

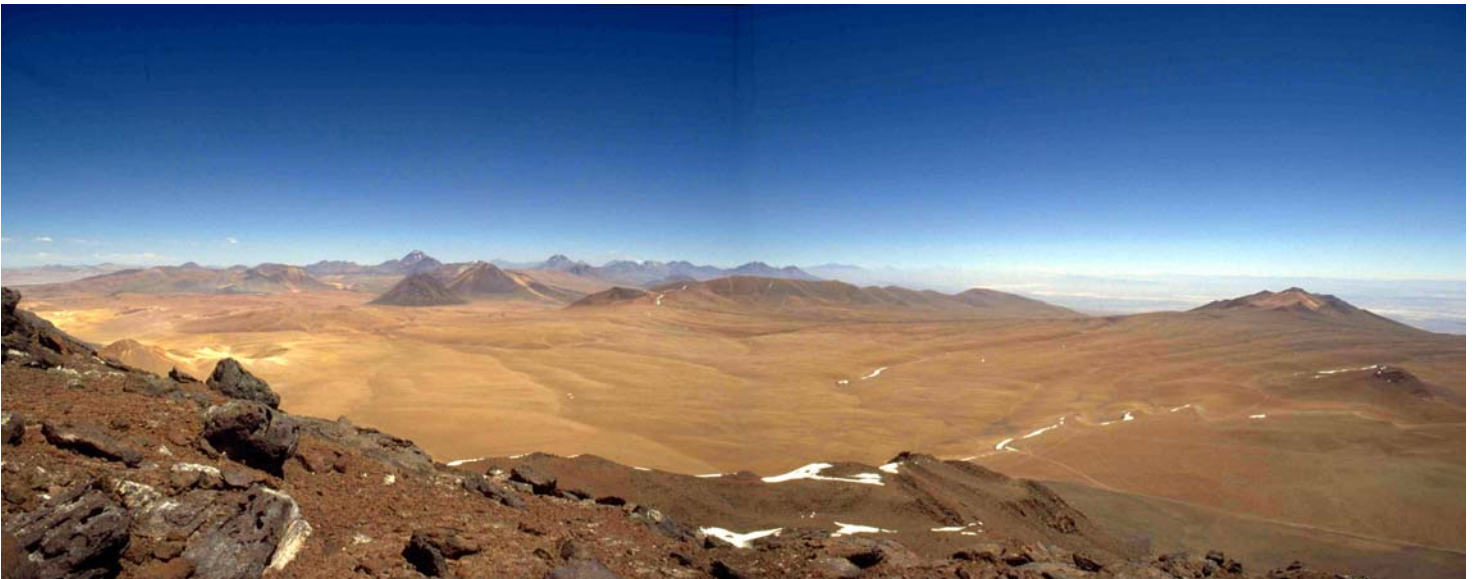


# **Atacama Large Millimeter Array**

## **Quarterly Report**

**For the Period Ending  
30 June 2003**

Submitted to the ALMA Board  
For the Joint ALMA Office  
By M. Tarenghi, Director





**Table of Contents**

<b>1.</b>	<b>Activities of the Joint ALMA Office (JAO)</b>	<b>4</b>
1.1	Project Management and Organization	4
1.2	JAO Goals	4
<b>2.</b>	<b>Project Report</b>	<b>5</b>
2.1	Management	5
2.2	Site	8
2.3	Antenna IPT	12
2.4	Front End Sub-System Management	19
2.5	Back End (BE) IPT	49
2.6	Correlator IPT	56
2.7	Computing IPT	60
2.8	System Engineering and Integration IPT	65
2.9	Science IPT	70
	<b>Acronym definitions</b>	<b>75</b>

## **1. Activities of the Joint ALMA Office (JAO)**

### **1.1 Project Management and Organization**

#### 1.1.1 Management IPT

The Management IPT continued to hold weekly teleconferences during this quarter, with all IPT Leads and Deputy Leads joining the Management IPT in a separate teleconference every other week.

#### 1.1.2 ALMA Week

The 2003 ALMA Week took place in Victoria, Canada from 02.06.2003 to 06.06.2003. This meeting was attended by about 90 key personnel from the entire Project. Face to face discussions of the ALMA status as well as specialized meetings were organized. All presentations can be seen on the ALMAEDM page 'Meetings'.

#### 1.1.3 Chile Issues

Major steps were taken towards the completion of the concession agreement. Authorization to start the road activities was received from the Chilean authorities.

#### 1.1.4 Interaction with the National Astronomy Observatory of Japan (NAOJ)

Several discussions with representatives of the NAOJ were organized by teleconference or face to face in Washington and Victoria. The final table of 'values' was submitted to the ALMA Board. On the same occasion a discussion on operation of the Concept Array was initiated.

### **1.2 JAO Goals**

#### 1.2.1 Goals for the Next Period

- *Obtain access to the site and begin site development.* This is close to being accomplished
- *Construct a Project Schedule that links all the milestones and identifies all the dependencies.* Started but not complete. It will be a major goal for the next period.
- *Continue construction of a detailed Operations Plan.* An Operations Plan group was created and the final report is expected for the end of 2003.

- *Complete the Front End Production, Safety, and Public Relations Plans.* Good progress in the Front End and Safety. Need to improve the Public Relations Plan with the creation of an IPT.
- *Assist the ALMA Board Japan Negotiating Team.* This has been accomplished but will continue in the next period.

## **2. Project Report**

### **2.1 Management**

#### **2.1.1 European Project Office**

Fabio Biancat-Marchet transferred to the ALMA Division at ESO in May to become the person responsible for the Backend Subsystem at ESO. Alain Baudry continues as deputy for the Backend IPT with Fabio's support in managing the backend work packages in Europe. A. Neves resigned from his position as European Project Manager on 5 June, necessitating the search for a successor. R. Kurz has postponed his retirement and will stay at ESO on a part-time basis until the position of European Project Manager is filled.

The European ALMA Board (EAB) met in Garching on 12 May in advance of the ALMA Board meeting at ESO on 26-27 May. The EAB received and noted status reports on the project. They reviewed the document on the ALMA Phase 2 procurement strategy submitted to the ESO Finance Committee (FC) and requested that the FC recommend endorsement by the ESO Council.

At its meeting on 13-14 May, the ESO FC considered both the overall ALMA Phase 2 procurement strategy and the requested approval of ten contracts with European organizations for Phase 2 work packages plus two industrial contracts. FC requested modifications to the procurement strategy that strengthen the ESO management of the work packages. At a subsequent extraordinary meeting on 10 June, FC voted to recommend approval of the revised procurement strategy to ESO Council and approved the award of all 12 of the contracts for a total commitment of more than 20M€.

At its meeting on 10-11 June, ESO Council received notification that France had lifted its *ad referendum* and confirmed its positive vote in July 2002 on the Council resolution approving ALMA Phase 2. Council also received the good news that the Chilean Parliament completed ratification of the ALMA Agreement between ESO and Chile on 10 June. Later in the meeting Council approved the ALMA Phase 2 procurement strategy.

The European Scientific Advisory Committee (ESAC) met in Garching on 12 June. The ESAC nominated P. Cox, J. Richer, P. Schilke, L. Testi, and E. van Dishoeck to be the European members of the ALMA SAC.

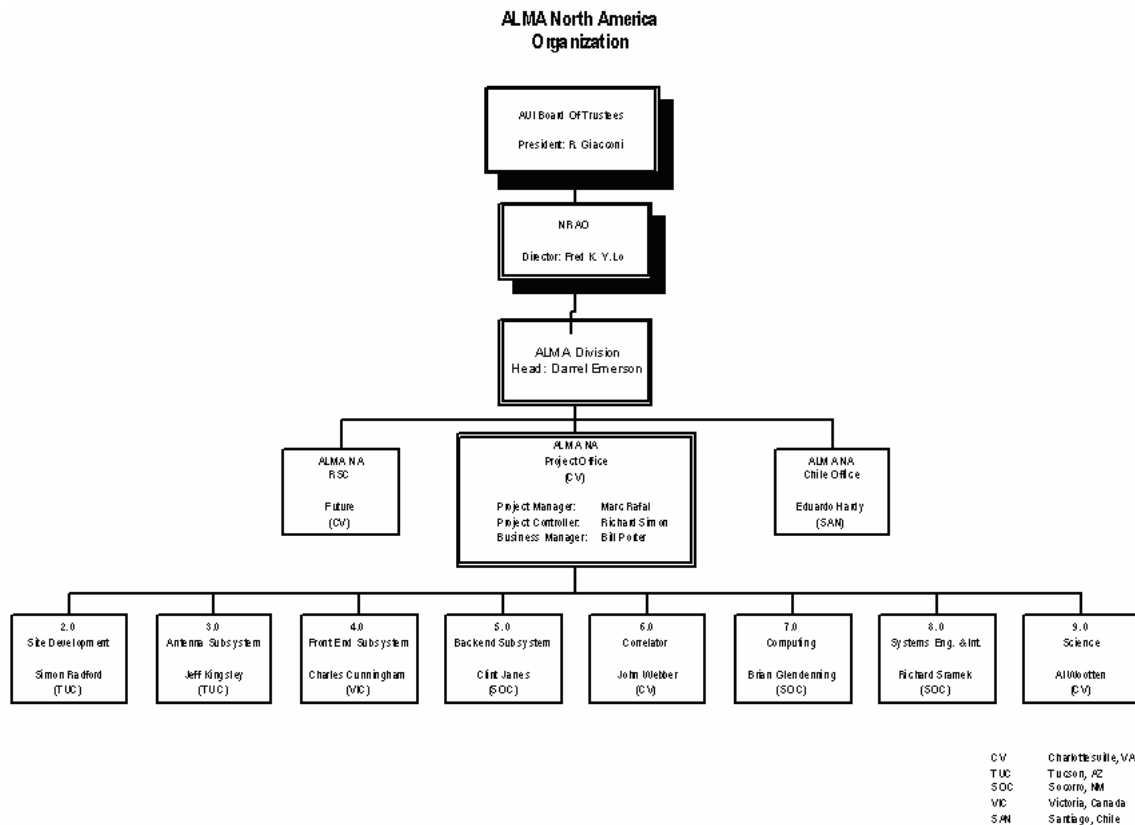
The project was presented to combined academic, governmental, and industrial audiences at ALMA Day events in Berne, Switzerland, on 30 April, and Porto, Portugal and Rutherford Appleton Laboratory in the UK on 16 June.

### EPO Goals for the Next Period (3rd Quarter 2003)

- Complete the award of European Phase 2 work package contracts (Milestones 8105 and 8110)
- Complete the recruitment of the European Project Manager and European Project Scientist
- Formulate the European ALMA 2004 budget and financial projections, and submit to the JAO by 1 September (Milestone 8122)
- 

### 2.1.2 North American Project Office

NRAO has established an ALMA Division under the NRAO Director. The ALMA Division includes ALMA Construction and will ultimately include the RSC, development activities for enhancements and the management of operations activities in Chile. Darrel Emerson has been appointed the head of the ALMA Division. Marc Rafal, as ALMA Project Manager, remains responsible for all construction related activities. An organizational chart showing the new Division is shown below.



Detailed planning for the consolidation of the ALMA staff from Tucson to Charlottesville is progressing. To better integrate the Front End activities now split between Tucson and Charlottesville staff, a new Front End group will be formed that combines the Band 6 and Front End integration activities. John Payne has been selected to lead this new group.

Based on recommendations from the ALMA Management Advisory Committee, a review of project tracking and reporting is under way. Coordinated with the JAO and ESO, we have interviewed potential consultants who could assist the project in developing a more complete set of tools to collect and analyze data.

The ALMA North American Science Advisory Group has been formed by the NRAO Director. This group is an analog of the ESAC. Members of the ANASAC include:

Leo Blitz	U. C. Berkeley
Andrew Blain	Caltech
Chris Carilli	NRAO
Dick Crutcher (Chair)	U. Illinois
David Hollenbach	NASA-Ames
Jason Glenn	U. Colorado
Dan Jaffe	U. Texas
Luis Rodriguez	UNAM Morelia
Dave Sanders	U. Hawaii
Xiaohui Fan	U. Arizona
Christine Wilson	McMaster University
Lee Mundy	U. Maryland
Jean Turner	U. C. Los Angeles
Min Yun	U. Massachusetts
Phil Myers	Center for Astrophysics
Doug Johnstone	Herzberg Institute
Mark Gurwell	Center for Astrophysics
Joan Najita	NOAO

The ANASAC has met via telecon and will have its first face-to-face meeting in August this year.

### **Goals for the Next Period (3rd Quarter 2003)**

- Develop plans for improved project tracking and reporting
- Formulate the North American ALMA 2004 budget and financial projections, and submit to the JAO by 1 September

## 2.2 Site

### During the reporting period :

The contract for M3 for the design/engineering of the AOS facilities (initially, for the preparation of the project master plan, architectural programs for the buildings, antenna station interconnection layouts, and value engineering study of correlator cooling options) has been extended to provide schematic design, design development, and tender and “For Construction” documentation for the entire facilities to be provided by N.A.

### Final Approval of architectural program for all AOS Buildings (Milestone 8208, 01 February 2003)

Architectural Program version E was accepted by the JAO on 03 March 2003 and M3 is now in progress in preparing the above referenced contracted documentation. The hangar is an option and may be constructed later.

### Freeze the Joint Antenna Station-Antenna Interface Control document (Milestone 8213, 15-Feb-2003)

The corresponding ICD ALMA-20.02.00.00-34.00.00-D-ICD was approved by the JAO on 24-Jun-2003. M3 is proceeding with the design and engineering of the antenna foundations.

### 8216 Freeze Center Cluster Configuration (Milestone 8216, 01-Mar-2003)

The configuration specification prepared by the Science IPT (ALMA-90.20.00.00-001-E-SPE) has been submitted for approval. The Site Development IPT is proceeding on the assumption that there will be no further change to this document.

The tender documents for the geo-technical studies for the center cluster of antenna foundations (down and cross-hole investigations) are being prepared by M3.

### AOS Foundations Central Cluster Critical Design Review (Milestone 8222, 01 March 2003)

The review process of a first set of schematic design documentation was completed on 23 May 2003. Due to a number of obstacles, including the time to develop a unified foundation concept, uncertainty regarding transporter requirements and associated site grading profile, fiber optic cable specifications and installation methods and some electrical requirements, design/engineering focus will shift to the “Inner Array” foundations not affected by some of these obstacles. The tender and “for construction” documentation for these foundations (Milestone 8224, 15 Apr 2003) will then be available in early October 2003.

### Critical Design Review for the Foundations, Superstructure and building envelope for the AOS Building (Milestone 8250, 01 April 2003)

The conceptual design documentation of the Technical Building was presented during the ALMA week in June and was commented on by the audience. These comments are currently being implemented. The JAO authorized M3 to proceed with the preparation of



design-development documentation and subsequently with tender/construction documentation for the foundation system, the superstructure and the building envelope (exterior walls and roofing) for the Technical Building. This documentation is now scheduled to be complete in October 2003.

Construction/Tender documentation for the Foundations, Superstructure and building envelope for the AOS Building (Milestone 8252, 31 May 2003)

This documentation is scheduled to be completed in early 2004. The Development IPT will try to mitigate these delays by bidding some work with unit rate contracts or as design- build contracts in parallel with the final design effort.

The tender documentation for the establishment of a construction traffic access road (Milestone 8290, 09 May 2003) was completed on time. On 10 May 2003 tenders were opened and clarification meetings were held on 22 May 2003.

The contract for the establishment of a construction traffic access road to the OSF and the AOS (Milestones 8292, 01 Apr 2003) was signed on 25 June 2003. Contract duration will be 120 calendar days or less, weather permitting. Contract completion is therefore anticipated to be on 31 Oct 2003. Site IPT is currently waiting with a signed contract in hand for “green light” from the ESO and AUI representatives in Chile to start the job. Final land access and beginning of the work in the field is anticipated to be during the first or second week in July 2003.

The contract for the Design/Engineering of the Access Road to the OSF and AOS (Milestone 8300, 13 February 2003) was signed on 17 March 2003. The work is scheduled to be complete on 04 August 2003.

The critical design-development documentation for the Design/Engineering for the Access Road to the OSF and AOS (Milestones 8302 and 8304, 31 March 2003) was reviewed during the ALMA week in June 2003. The JAO authorized to proceed with the preparation of “For Construction” and tender documentation. The contractor is now proceeding with this task.

The tender and construction documentation for the Access Road to the OSF and AOS (Milestone 8306 16 July 2003) are currently being prepared by the contractor INGELOG, Chile. The prerequisite topographical services for the preparation of this documentation were started on 19 May 2003. The recent heavy snowfall at Chajnantor proper has delayed this activity. The contractual completion date on 04 August 2003, will not be affected substantially. There will be no impact on the following milestone 2.025.8308 Access Road, Construction Contract to be signed on 16 July 2004.

The ALMA and Contractor’s Camp tender documentation (Milestones 8320 and 8330, 01 March 2003) was completed and tender documents for the dismantling and removal from the Paranal Observatory, transport and re-installation including site work were sent to seven prospective bidders on 02 May 2003. Tender opening was on 09 June 2003 and tender clarification meetings were held on 11 June 2003. The contract preparation is in progress.

The ALMA and Contractor's construction contracts (Milestones 8324 and 8332, 01 May 2003). It is anticipated that the contract will be signed during the first week in July. This is compatible with the construction traffic road opening work beginning at about the same time. Camps contract completion will be approximately on 30 Oct 2003. The architectural finishes roofing, electrical and mechanical distribution and installations inside the camps shall be done with a number of smaller contracts and in accordance with the needs of occupancy.

Design-Engineering Contract award for the Technical Facilities of the OSF, (01-Jun-2003). The tender documents for the Design/Engineering of the Technical Area Facilities were completed on 17 February 2003. The tender documents were dispatched to the 39 bidders on 09 April 2003. Tender opening of the six incoming tender proposals was on 16 June 2003. The technical tender evaluation was completed on 01 July 2003. Contract signature is anticipated to be on 15 August 2003 with written ESO FC approval procedures included.

The (extended) Power Feasibility Study (Milestone 8370, 31 March 2003) including aspects pertaining to the entire project and particular the feasibility of the connection of the power station to the local gas pipeline in San Pedro de Atacama was completed by the consultant Fichtner on 07 April 2003 and was commented on by ESO on 28 April 2003. Fichtner now recommends positioning the ALMA power at the OSF Site. Subsequent to the electric power presentation during the ALMA week in June 2003 several further options regarding natural gas availability are being pursued. The electric power supply plan is currently being elaborated by the Site Development IPT and shall be presented to the JAO on 31-Aug for approval.

Concerns :

Time frame of the incorporation of Japanese requirements into the current design/engineering process.

Next Period/Goals :

Complete the CDR for the Antenna Stations Central Cluster at the AOS (Milestone 8222)

Complete the CDR for the Building foundations and envelope at the AOS (Milestone 8250)

Complete the Tender and "For Construction" documents for the Technical Building foundations and envelope at the AOS

Complete the Tender/Construction documents for the antenna stations at the central cluster at the AOS (Milestone 8224)

Complete the CDR for the finishes and installations for the Technical Building at the AOS (Milestone 8260)

Completion of the tender/Construction Documents for the Access Road (Milestone 8306)

Construction traffic road open to OSF on 15 August 2003

Construction traffic road open to AOS on 15 November 2003 (Milestone 8294)

Contract for the design/engineering of the OSF Technical Facilities awarded (Milestone 8340)

Contract for the construction of the ALMA Camp and the Contractor's Camp awarded (Milestones 8304 and 8324)

ALMA Camp in part habitable, board and lodging services established 30 September 2003 (Milestone 8326)

Contractor's camp in part habitable board and lodging services established 30 October 2003 (Milestone 8334)

Completion and approval of the document "Conditions, Rules and Regulations applicable to Contractors executing Atacama Large Millimeter Array (ALMA) Contracts on the ALMA Observatory located near the villages of San Pedro de Atacama and Toconao, II Region, Chile, South America"

### 2.3 Antenna IPT

The Antenna IPT continues to be fully focused on the delivery of the AEC antenna and completion of the VertexRSI contract. In parallel the antenna group is supporting the AEG effort on the VertexRSI antenna that has included holography and installation of test metrology. The nutating subreflector system is being prepared for installation on the VertexRSI antenna in July 2003. In addition the second optical pointing telescope is also being prepared for installation on the AEC antenna that will also occur in July. Progress has also been started on the production antenna procurement bid package that includes ICDs, Statement of Work, Technical Specifications and detailed plans. All these efforts will continue to be a significant challenge since the antenna IPT has many parallel tasks occurring as a result of the delayed antenna delivery schedules. Progress is being made in all areas but is limited by manpower.



Figure 1. Shows the status of the antennas at the ATF site as of June 2003.

#### VertexRSI Antenna

The VertexRSI prototype antenna was delivered to the ALMA project on March 20, 2003 with a small punch list of remaining items to resolve. It then was turned over to the AEG for the beginning of antenna testing starting out with holography. Several sessions were planned around the AEG activity for VertexRSI to return to the site and complete the punch list items and resolve newly discovered problems.

In early April the contractor returned to complete many of the punch list items. The drive system amplifiers were replaced and the servo acceptance testing was repeated to verify the antennas servo performance. The AC drive motor ripple problem was solved.

In June 2003 while AEG technicians were installing cables on the VertexRSI antenna accidental motion of the man lift damaged one of the feed legs. This accident damaged a portion of one of the CFRP feed leg as shown in Figure 2. VertexRSI was notified and a CFRP consultant along with the NRAO antenna group and a representative from VertexRSI inspected the entire feed leg structure for damage. It was assessed to be only

local damage and a repair procedure was proposed by the consultant and approved by the original feed leg manufacture and VertexRSI. The repair occurred one week after the initial damage. Before and after surface accuracy maps from the AEG show no change in the surface accuracy due to the damaged and repaired feed leg.



Figure 2. Section of damaged feed leg.

The Contract will return to site in early July to resolve problems between the ACU, PTC and AMB systems that still remain. This will also include failed stow pins motors and the relay controlling the hexapod will be repaired along with several other small items. The main major outstanding issue is the 150-usec response time of the ACU. The Contractor is working to resolve this issue but it is unclear if it will be resolved by the end of July. This issue will not impact antenna testing.

Once the site work is completed in early July 2003 the remaining items on the punch list are pertain to finalizing the documentation. This will then be incorporated into the acceptance and verification matrix as it is completed. The latest VertexRSI schedule reports that the punch list items are schedule to be completed by the end of July 2003.

### **AEC Antenna**

The Contractor started the erection work of the temporary shelter used for the assembly of the antenna during the 2<sup>nd</sup> half of March as shown in Figure 1. This work protracted through the month of April. During the month of April the assembly of the mechanical structure (base and yoke) and of some mechanical subsystem started (access platform, electronic cabinets, Azimuth motors, etc. )

The CFRP Cabin and the BUS assembly and measuring phases were completed during the first half of May at the Oggiono factory in Italy. The parts (the cabin and the two BUS halves) were positioned on special tools designed for handling and air transport. On 16

May the three pallets were loaded in the cargo bay of an Airbus transporter plane, at the airport of Milan for immediate departure to Albuquerque, with some intermediate stops. On 22 May the parts arrived on site.



Figure 3. Arrival of the AEC BUS in Albuquerque in May.

The assembly team on site has been growing steadily, in parallel with the delivery of the equipment, both for electrical and mechanical fitting and for the laser tracking metrology, permanently used at every major step of integration.

As per 25<sup>th</sup> June the cabin was finally installed and precision adjusted onto the yoke arms. The BUS is expected to be mounted onto the cabin in the next days, and the panel adjusters and panel will be mounted directly on the antenna in parallel with the completion of the antenna outfitting.





Figure 4. Receiver cabin mounted on antenna pedestal.

The team on site has started to work in double shift with the objective to have the antenna assembly and the start up phase of the drives completed at the beginning of August. The ability to maintain this tight schedule will also depend on the flawless operations leading to the internal acceptance, the preparation for shipment and the shipment of the various

parts and subassemblies still in Europe (receiver boxes, feed shutter, metrology parts, insulation....)

Outfitting of the metrology system is planned in parallel with further antenna debugging and testing.

### ***Technical details***

Antenna Mount: The mechanical mount of the antenna has proceeded with no major problems, whereby a number of nonconformities and discrepancies with the plans have been encountered and were or are in the process of being rectified. Certain operations, like the central mounting of the guiding system of the cabin took slightly longer than anticipated due to the necessity of precision machining shims, operation not done given the very limited pre-assembly in Europe.

Cabin: Prior to its departure from Italy the cabin had been partially furnished with the floor the covers and the interface to the optical pointing telescope.????? The flame spray process used for EMC/RFI protection had been applied and inspected at the factory by ESO personnel with a dedicated meeting having the aim to review the detailed implementation of all EMC/RFI devices (penetrations, waveguides...). Minor improvements and modifications were agreed with the Contractor. The completion of the finishing of the cabin occurs with the cabin installed in the antenna

BUS and Reflector: The BUS is completed and equipped with mounting fixtures for the panel adjusters. All panels and panel adjusters have been manufactured. The original plan to install the panel adjusters on the BUS with the BUS on the ground in one of the NRAO buildings had to be cancelled due to the necessity to repeat the bolting together of the two BUS halves originally performed without the check of the laser tracker. This operation is now finished but the window of availability of the NRAO building is now closed. The mounting of panels and panel adjusters should be rather straightforward thanks to the tools and the procedures prepared and tested during pre-assembly in Italy. The goal is to have the panel adjusted by using a laser tracker below or close to 100 micrometers during the first mounting, for which purpose a further reference measuring of individual panels was done at the Media Lario factory. Verification towards ALMA is planned to be performed by photogrammetry.





Figure 5. Lifting assembled BUS onto the mounting fixture.

ACU and Software: A meeting is taking place (the third) in Europe to test the ACU together with the ABM provided by ESO to the subcontractor of AEC Microgate, prior to its shipment to the site. Work on the metrology software has started and is being reviewed for progress.

Subreflector and mechanism: The subreflector mechanism has been integrated in the apex structure and has been extensively tested. It is being shipped at present. The aluminium subreflector has been machined down to specification and it has been internally accepted by the consortium. Reflectivity tests are planned at ESO to verify its scattering performance for the solar observation specification.

Analyses and Documentation: The Contractor was notified at regular intervals of the importance of the documentation of the project both at design and analysis level and as built. So far a considerable effort has been made by the Consortium in updating the complete drawing set, and steady progress can be reported. A similar effort is now being sought regarding the remaining update of the documentation. The error budgets and performance of the antenna have been delivered and are up to date. The contractor is concentrating on the acceptance plan and procedures. A dedicated meeting is planned for the next days.

Although tremendous progress and good momentum can be reported now, the schedule of the antenna has nevertheless somewhat shifted compared to the last report, mainly due to the delay in completion of BUS and cabin and the slow start of the site activities back in March/April 2003. The Preliminary Acceptance date indicated by the Contractor is now 08 August 2003, with no contingency. In order to arrive at this date the Contractor is resorting to double shift work on site and counting on no delay with the last shipments. The further testing phase of the antenna is still scheduled to be completed at the end of August 2003, but the detailing of this phase remains rather schematic for the moment.

Site Activities AEC antenna Considerable effort is being produced in planning and preparing the outfitting of the AEC antenna with the cabling and the equipment necessary for the AEG activities. This is a joint effort done in close collaboration between the ESO and NRAO parts of the antenna IPT.

### **Antenna Transporter**

The ICDs for the transporter to other IPTs are progressing and are in the final phase of completion that will occur in early August. Two transport feasibility studies have been issued by ESO. In June 2003 a meeting was held at KOEGEL to discuss one of the transporter feasibility studies. The results presented are good. All requirements can be met and they have selected slightly different vehicle architecture together with hydrostatic drive and a dual engine configuration. The final report for this study and the other one will be completed in July 2003.

### **Optical Pointing Telescope**

The optical pointing telescope for the AEC antenna is now in the final fabrication phase and schedule to be installed on the AEC antenna in late July 2003. This telescope is a copy of the one built and operating on the VertexRSI antenna but with a slightly different interface due to the mounting location. The telescope will be used for testing and acceptance of the AEC antenna.

### **Nutating Subreflector**

The nutating subreflector is schedule to be installed on the VertexRSI antenna in early July for final testing and evaluation on the antenna in advance to the delivery of the evaluation front end. The testing on the antenna will occur with the engineering control test software. The final system software control is being integrated in the lab in Tucson along with the front end by the computing IPT. A special demonstrator unit was made available for this software testing so evaluation on the antenna could occur in parallel. The JAO decided at ALMA week that one nutator would be shared to evaluate both antennas.

### **Antenna Procurement**

Progress has been made for the production antenna procurement. The required ICD and the technical specification documents have been identified and the various IPTs are making progress. Work has begun on the statement of work and technical specifications.

## **2.4 Front End Sub-system management (ALMA Work Package: 4.075)**

### *Front End IPT All Hands Meeting*

The Front End IPT organized an all hands meeting in Groningen, the Netherlands, on 16<sup>th</sup> - 18<sup>th</sup> of June 2003. It was hosted by NOVA with assistance from SRON.

The meeting was very successful and provided IPT members with a general overview of the schedule, the overall receiver design and the way the various sub-systems integrate together. Representatives for each of the major sub-systems presented their designs. Particular progress was made in the following areas:

- Internal Interface Control Documents: in particular the cartridge/front-end interfaces
- Front-end specifications and requirements
- Receiver design
- Monitor and control concept
- Amplitude stability

More details, including agenda and meeting minutes, can be found in the documents and presentations stored in ALMAEDM available at the following URL:

<http://almaedm.tuc.nrao.edu/forums/alma/dispatch.cgi/almaprojmeetings/docProfile/100651/d20030624065028/No>

### *ALMA Week*

At ALMA week on 2<sup>nd</sup> – 6<sup>th</sup> June 2003 in Victoria, Canada, the current status of the Front End IPT was described to the rest of the project. In dedicated sessions, progress was made in developing the external ICD's between the front end and the following other ALMA sub-systems:

- Antenna: largely complete
- Back-end: awaiting input from the systems IPT
- Computing: in progress
- Site: in progress

### *URSI National Radio Science Meeting*

At the 2003 URSI National Radio Science Meeting, held 23<sup>rd</sup> - 26<sup>th</sup> June 2003 in Columbus / OH, the specifications and current design for the ALMA front end was presented.

*Status European Front End Work Package Contracts*

At their 105<sup>th</sup> Meeting held on 10 June 2003 in Garching, the ESO Finance Committee approved the award of contracts for the following FE work packages:

- Development and pre-production (8 units) of Cryostats
- Development and pre-production (8 sets) of Common Optics, Windows and IR filters
- Development and pre-production (8 units) of Band 7 cartridge
- Development and pre-production (8 units) of Band 9 cartridge
- Assembly and testing of 2 prototype Water Vapor Radiometers
- SIS junction process development and technology support

This approval allows for final contract negotiations and signature of the contracts at short notice. Contract signatures are expected in July and August 2003.

*Alternative supply of InP transistors*

Given the uncertainty in obtaining InP transistors for the ALMA project, alternative sources have been investigated. So far the following organizations have been contacted to discuss their capability to supply the required devices:

1. Swiss Federal Institute of Technology (ETH) in Zürich, Switzerland ETH has produced InP transistors in the recent past and these devices have been successfully used in cryogenic microwave amplifiers. However the production facility at ETH is limited to small scale production in a laboratory environment so far. The discussion with ETH has led to a draft proposal from their side to transfer the InP HEMT technology to a larger in-house production facility and subsequently produce the required amount of transistors needed for the ALMA project.
2. Fraunhofer Institute für angewandte Festkörperphysik (IAF) in Freiburg, Germany IAF has produced InP HEMTs on 2" wafers in the past but moved on to the production of InP meta-morphic HEMTs on 4" GaAs wafers which are more compatible with main stream industry production processes. Sample devices of the meta-morphic HEMTs have been delivered to the project for evaluation of their performance at cryogenic temperatures. This evaluation is currently taking place at Astronomical Center of Yebes in Spain. With a positive outcome of those tests a medium sized (pseudo-) industrial supplier of InP devices would be available.
3. Chalmers University of Technology, Department of Microelectronics, in Gothenburg, Sweden

Chalmers has produced InP HEMTs on a small scale in the past and demonstrated good performance with those transistors in cryogenic microwave amplifiers. They have concrete plans to start development and production of InP transistors in the near future. A request has been made to receive samples for evaluation.

*Summary of On-going Work*

<b>On-going work</b>	<b>Due date</b>	<b>Progress</b>	<b>Comments</b>
Revised front-end specifications and requirements	1 Jan 2003	On going	Draft available, awaiting input from the systems IPT
Front-end internal ICD's	15 April 2003	On going	Draft only, progress made at IPT meeting
Cryogenic performance of dewar determined	1 Jan 2003	Completed	Performance within specification. Minor problems with engineering model discussed later
Local oscillator chains for all four bands delivered	1 Jan 2003	On going	Band 7 chain not yet delivered due to late delivery of cold multiplier
Pre-prototype DC support electronics and monitor and control modules delivered to cartridge manufacturers	1 March	Completed	Delivered in May '03
Optics and calibration design frozen	2 <sup>nd</sup> Quarter 2003	On going	Optics design complete and verified. Calibration design on-going. Minor problems discussed below
Integration center design meeting	Jan 2003	Completed	Minutes available
Cartridge body design frozen	1 Sept 2003	On going	
DC support electronics design frozen	1 Oct 2003	On going	
Monitor and control design frozen	1 Oct 2003	On going	
Local oscillator design frozen	1 Oct 2003	On going	
Chassis design frozen	1 Oct 2003	On going	
Front end delta-PDR	1 Sept 2003	On going	
Integration center design finished	1 Oct 2003	On going	Likely delayed

### Front End Sub-system engineering (ALMA Work Package: 4.075)

The FE sub-system engineers made substantial efforts in the preparation and active participation of all the meetings and workshops the FE IPT was involved this quarter.

The main activities concentrated on the preparation of external Interface Control Documents between the FE sub-system and subsequently Antenna, Back-end, Computing and Site. In addition the FE specifications and requirements document was completed as far as possible. Final completion awaiting further input from the System Engineering & Integration IPT. These activities were done in close collaboration with the involved sub-system IPTs and the System Engineering & Integration IPT. A draft version of the ICD between Antenna and FE was available in June '03 and is awaiting final comments from the Antenna IPT.

Support, including review, was given to the SE&I IPT in the preparation of various project wide documents.

Coordination in the preparation and structuring of FE IPT internal ICDs has been made. Especially at the FE IPT All Hands meeting good progress was made in defining those interfaces which are similar for the various cartridge bands. Currently these decisions are being implemented. A summary and all FE IPT internal ICDs can be found in ALMAEDM.

Analysis of various front end system budgets, including detailed noise and gain distribution allocations, were made. This information was presented to all design groups in the FE IPT.

### Cryostat ((ALMA Work Package: 4.080)

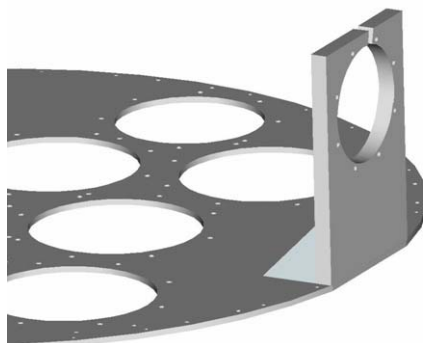
#### *Rutherford Appleton Laboratory*

An important level 3 milestone, 'cryogenic performance available' (#40303), was reached at the FE IPT All Hands meeting. Based on extensive static and dynamic measurements on an engineering model of the cryostat and complementary simulations performance data of the cryostat design was presented and found to be compliant with requirements.

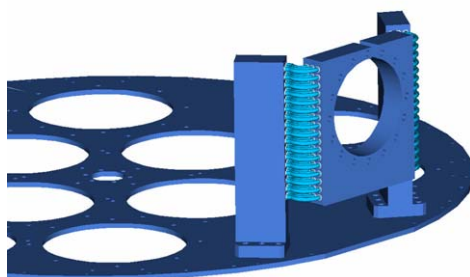
One problem was encountered with the 90 K shield on the engineering model of the cryostat that has been traced back to a badly welded joint between the 90 K plate and the attachment to the cryo cooler. This caused a higher thermal resistance and subsequently a too high temperature of the 90 K shield. Despite this too high temperature the 4 K and 15 K stages showed satisfactory performance. This proves the robustness of the design.

Cryostat simulations with a 90 K plate having a properly welded joint showed correct temperatures of this shield. Based on this knowledge a revision has been made to the 90 K plate which is currently implemented.

Figures 1 and 2 showing the original and the revised design of the 90 K plates.



**Figure 1 Original 90 K plate construction**



**Figure 2 New 90K plate construction**

Preparation of the procurement of the cryo cooler for the pre-production series has started. This cryo cooler is one of the major long lead items of the cryostat assembly.

Windows, IR filters and Common optics (ALMA Work Package: 4.090)

*Institut de Radio Astronomie Millimétrique*

At the FE IPT All Hands meeting another important milestone, ‘Freeze windows/IR filters design’ (#8770), was reached. Extensive results on electrical, vacuum and thermal properties were presented. For the windows three types of window design, 2 based on quartz and one based on HDPE, were evaluated. All showed acceptable RF performance and the choice was finally made on the leak rates. It has been decided to use for ALMA Bands 1 – 4 HDPE based windows, while for Bands 5 – 10 quartz.





**Figure 3 Engineering model cryostat fitted with quartz and HDPE based windows**

For the infra red filters it has been decided to use absorption type filters at both 90 K as well as 15 K stages to minimize the IR heat load on the 4 K stage. This choice was made on the basis of sample IR filters provided IRAM and tested by RAL in the engineering model of the cryostat.

A review of the common optics design had been scheduled for the FE IPT All Hands meeting with the objective to pass the level 2 milestone, 'Freeze optics design' (#8765). This review was based on results obtained by prototype measurements as well as advanced EM simulation of the design.

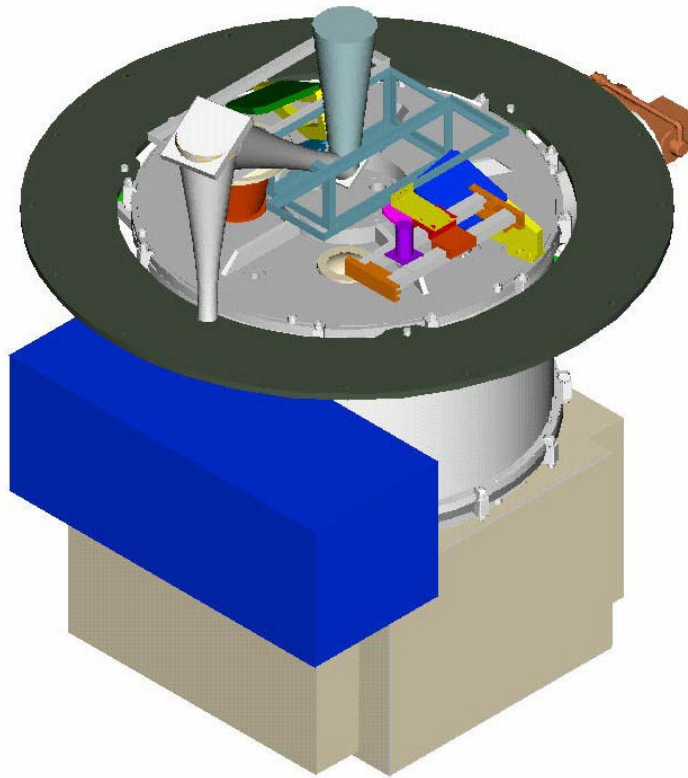
For all frequency bands the common optics design met the requirements, except for Band 3. The horn design used for Band 3 showed an anomaly at the lower edge of the operating band as well as the higher end. The problem at the lower edge is caused by a slightly higher return loss than specified. At the high end the excitation of a higher waveguide mode causes a distortion of the beam pattern. Due to the identified problem this milestone has not been passed.

The causes of these problems with the Band 3 feed horn are now well understood and a plan has been made to resolve them by September '03. It has been secured that no negative impact exists on the progress of the Band 3 cartridge tasks.



Front End Development (ALMA Work Package: 4.100)***NRAO Tucson***

Work has started on the detailed design of the receiver, concentrating on the block diagram overall layout and critical monitor and control and DC bias issues. Good progress is being made in designing the DC support electronics and agreeing the design with the cartridge manufacturers. The monitor and control concept involves an intelligent front-end and electronic tagging of the cartridges. The exact monitor and control board remains an issue as both the existing designs (AMBSI 1 and 2) have limitations. To meet our requirements and to simplify the interface to computing it is suggested that a new (simple) interface board is developed.



**Figure 4 Overall Front End concept**

The mechanical design of the chassis is being developed in collaboration with RAL staff and can proceed now that the local oscillator design is known and the volume of the front-end is defined in the antenna-front end ICD. Designs for the following sub-systems are being worked on as is their layout within the front-end:

- Monitor and control
- Power supplies
- IF switch

- Splitter for the fine tuning synthesizer
- Local oscillator reference switch

The layout and wiring/interconnection of the front-end in a way that allows for easy maintenance is being worked on.



**Figure 5 Front end internal layout**

The continued ATF work at NRAO Tucson remains a concern as it impacts the capacity for receiver and integration-centre design work.

(Focal Plane) Calibration System (ALMA Work Package: 4.115)

*Institut de Radio Astronomie Millimétrique*

Another run of calibration measurements using the semi transparent vane concept were made at the 30m at the IRAM telescope at Pico Valeta end of April '03. These measurements were made at a different location and with different material than those made in March. Results of these tests were presented at the ALMA Week by the Science IPT. The results obtained so far with the semi transparent vane concept show that an accuracy of at least better than 5 % is feasible.

A new amplitude calibration scheme, based on a combination of hot and cold loads coupled via a rotating grid to the input of a receiver, has been proposed by the Science IPT. It is believed that this concept will provide greater accuracy than the semi transparent vane, but concrete figures are not available.

A conceptual design for this new amplitude calibration device has been made and a heated calibration load that can be used between 85 to 950 GHz is being made.

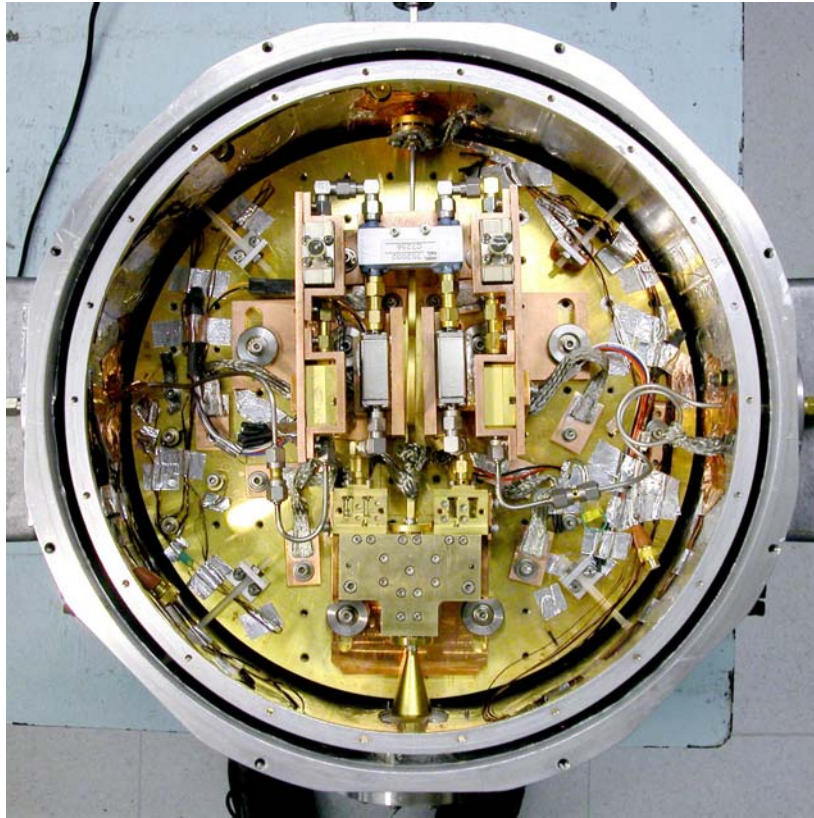
Given the major impact, larger design effort due to a more complex design and the higher costs involved, of changing the semi transparent vane based design to the newly proposed calibration device a formal change request should be approved by the JAO before the detailed design can be started. It has been agreed that this change request should be prepared by the Science IPT.

Meanwhile an assessment is going on if the design concept is compatible with the existing front end design and if there is an easy upgrade path feasible which allows an implementation of the semi transparent vane design initially that is than later replaced by the advanced calibration system.

Band 3 cartridge (ALMA Work Package: 4.145)

### ***Herzberg Institute of Astrophysics***

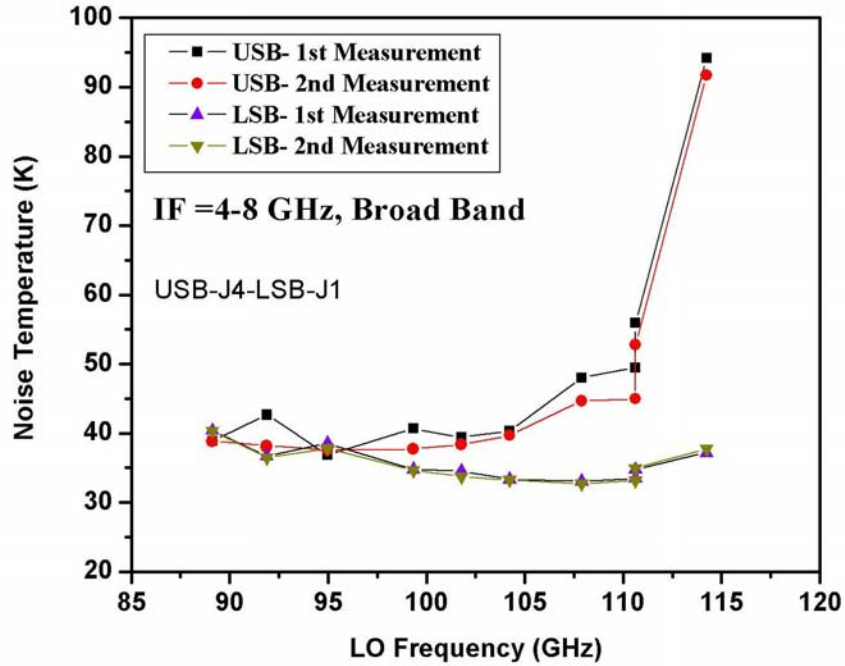
Following the successful testing of the Band 3 elemental mixer in the last reporting period, the HIA group have assembled and tested a complete sideband separating mixer based on a RF hybrid.



**Figure 6 Band 3 mixer mounted inside a test cryostat**

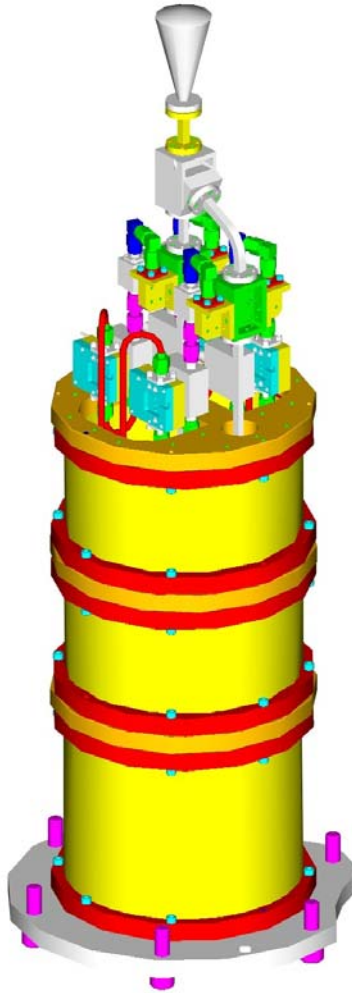
The photograph (Figure 6) illustrates the complete mixer mounted on the work-surface of a helium cryostat, prior to testing. The RF signal enters the hybrid via the conical feed horn at the bottom of the picture while the local oscillator signal is injected via waveguide at the top. The two IF amplifiers were constructed at the CDL in a collaborative effort.

The initial mixer results are very encouraging (shown in the Figure 7) and come close to achieving the specification of 34K (SSB) over 80% of the RF band. Note that the band to be covered with an IF centred at 6 GHz is 90-110 GHz. Preliminary measurements of the sideband rejection ratio indicates that it is better than  $-10\text{dB}$ .



**Figure 7 Band 3 mixer noise temperature vs. frequency**

The baseline solution for the Band 3 cartridge involves two such mixers with the RF input being polarization-split by an orthomode transducer. The illustration below shows the overall layout of the cartridge.



**Figure 8 Band 3 Cartridge Layout**

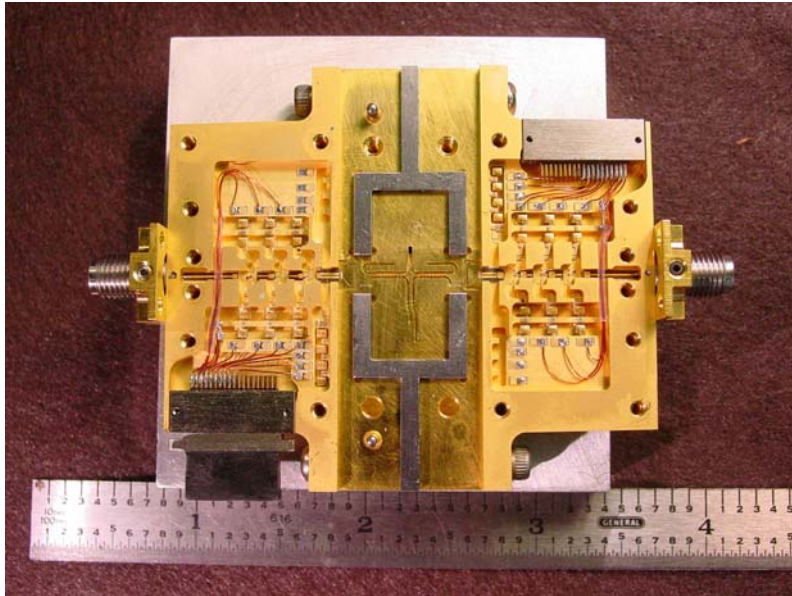
Work on designing Band 3 test and measurement equipment continues with the emphasis on finding commercial products that can replace custom-built apparatus and software. A mixer test cryostat that allows simultaneous testing of four devices is being developed. The Japanese cartridge test cryostat has arrived and is being outfitted with instrumentation.

Band 6 cartridge (ALMA Work Package: 4.160)

***NRAO Central Development Laboratory***

A sideband separating mixer for Band 6 based on a waveguide approach has been assembled as reported in the previous period. A photograph of the finished block - fully assembled with two integrated 4-12 GHz IF amplifiers and ready for testing is shown in Figure 9.

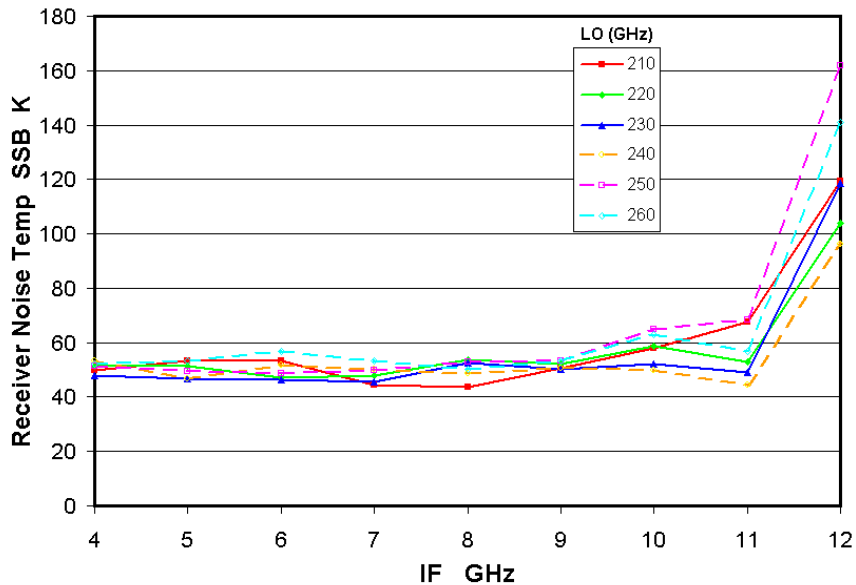




**Figure 9 Band 6 Mixer**

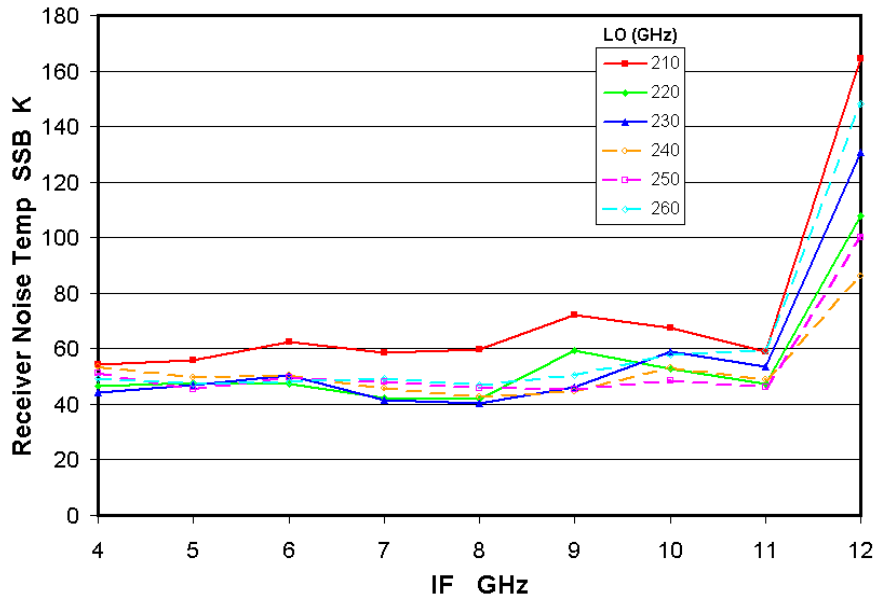
Initial RF tests of this mixer are very encouraging and indicate that ALMA specifications (78K SSB) over 80% of the RF band can be met.

UVA10-03-0403-L1362A-2-IH-C12-L56-2-372A-01-P.09.12  
 Measured 2003-05-27 & 2003-05-28  
 Upper Sideband



**Figure 10 Band 6 mixer USB noise temperature vs. frequency**

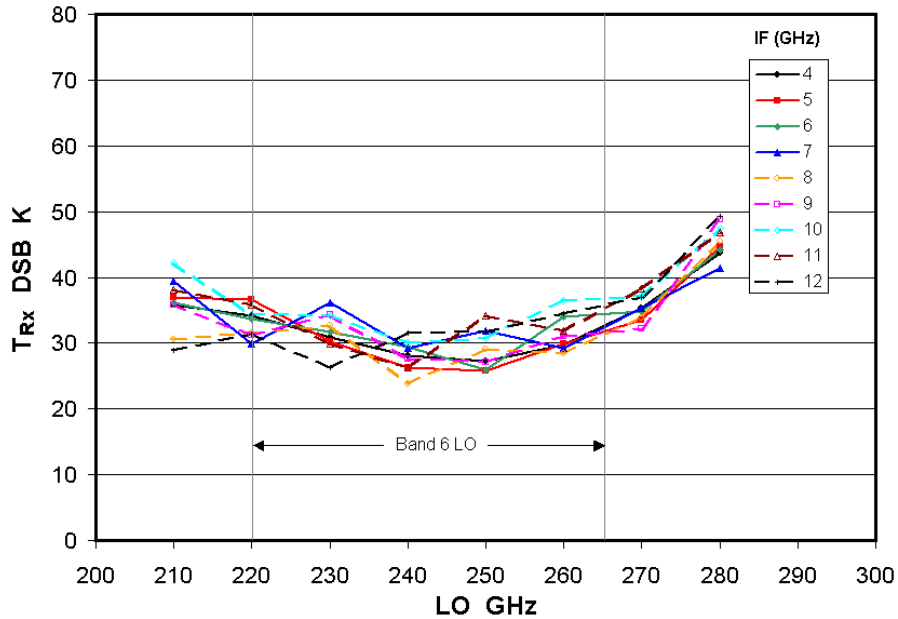
**UVA10-03-0403-L1362A-2-IH-C12-L56-2-372A-01-P.09.12**  
**Measured 2003-05-27 & 2003-05-28**  
**Lower Sideband**



**Figure 11 Band 6 mixer LSB noise temperature vs. frequency**

The testing of DSB elemental mixers continues as a backup solution. The latest results are shown in Figure 12 and indicate that the ALMA specifications (39K DSB) can be met with this technology.

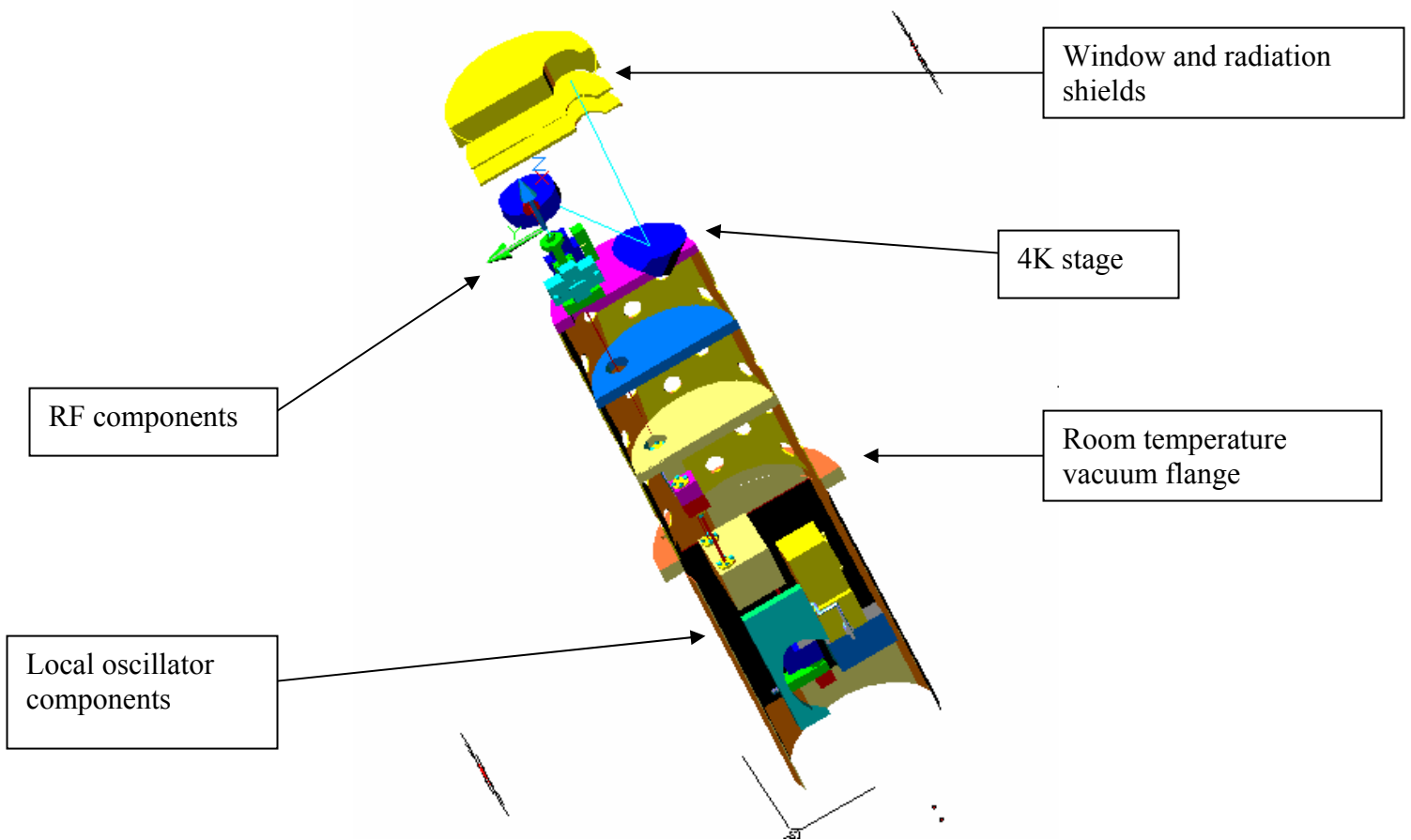
**UVA10-03-0403-L1362A-2-HH-C12-L56-2-375C-103-P.15**  
**Measured 2003-05-01 & 2003-05-02**



**Figure 12 Band 6 mixer DSB noise temperature vs. frequency**



The layout and internal details of the Band 6 cartridge such as the wiring heat sinks and the overall layout are being worked on in close collaboration with other parts of the Front End IPT. The current layout is shown below:



**Figure 13 Band 6 Cartridge Layout**

Band 7 cartridge (ALMA Work Package: 4.170)

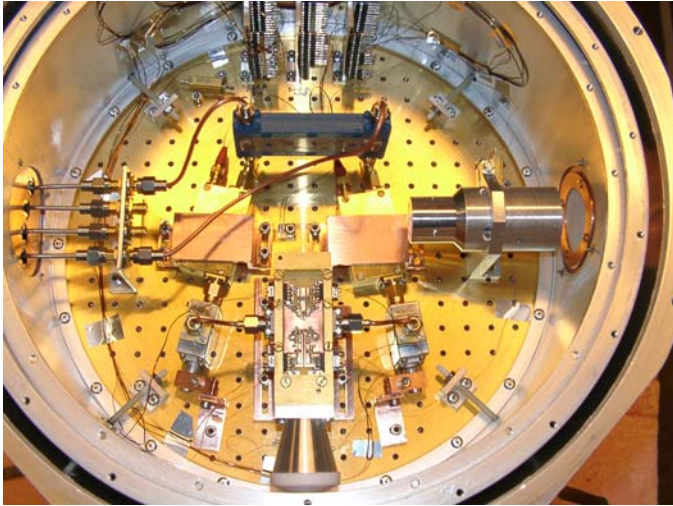
*Chalmers University of Technology / Onsala Space Observatory*

Work at Chalmers University in the framework of the Band 7 cartridge consisted of the following activities:

Performance of GaAs transistors, Mitsubishi MSFC4419G recently acquired in a batch of 2000 pieces, was evaluated in a cryogenic amplifier. They perform equally well as the previous batch, but give provide an extra 0,5 GHz of bandwidth, so the amplifier has an actual bandwidth of 3,9 – 8,5 GHz. This is measured without a circulator, which in the usual configuration will reduce the bandwidth down to the standard 4 - 8 GHz range.

Negotiations started with another department inside Chalmers University, Department of Microelectronics headed by Prof. H. Zirath, about the use of our amplifier as a test bed for their InP transistors and the preparation for small series production.

Testing of a scaled sideband separating prototype mixer (Figure 14); various results have been obtained and yet want better ones, which will be reported later.



**Figure 14 Scale model Band 7 mixer under test**

We are still in the process of tweaking our SIS technology; we have very good yield of SIS junctions, however we want specific features required by 2SB mixers, namely long wiring of the LO feed in 2SB mixer requires very low stress in Nb films; this is still in the process.

*Institut de Radio Astronomie Millimétrique*

### **Mixer related activities**

DSB mixer units: low IF capacitance type

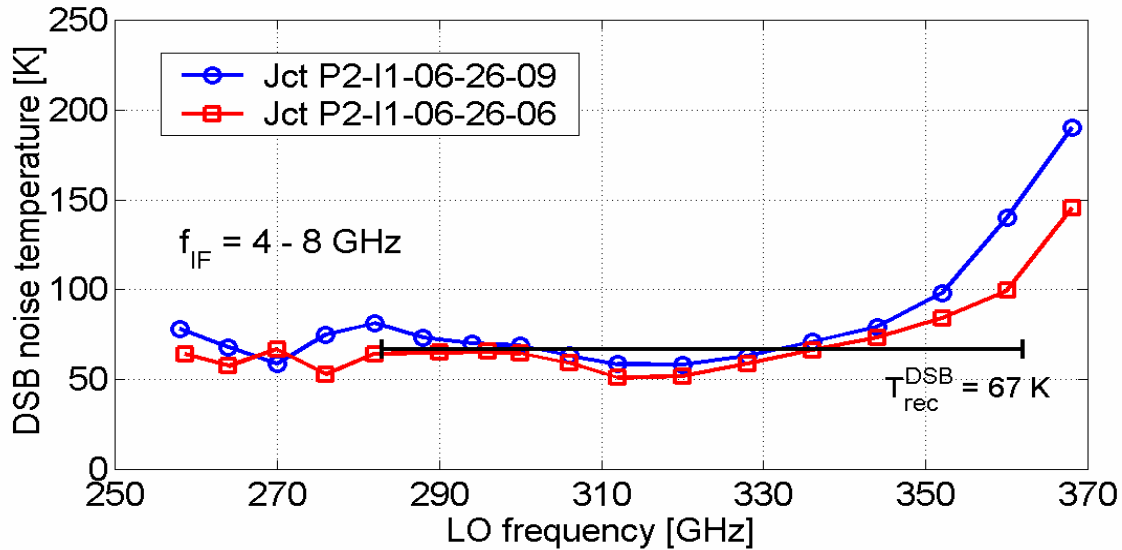
These are building blocks for the 2SB mixer assemblies.

A second wafer of the "type 2" junctions (low output capacitance, conservative technology) has been delivered by IRAM's SIS group.

The normal resistance is still too high. Two junctions were selected for their similar  $R_N$  values and similar RF performance in DSB tests (Figure 15). These junctions suffer from two problems:

- a) Normal resistance more than twice the design value ( $25\Omega$ );
- b) An error in the handling of finite thickness metal layers in the 2.5D modeling of the tuning circuit.

The SIS group continues to work to tune the process parameters to reach the prescribed barrier thickness and current density. The modeling error was recognized fairly early, but it was decided to carry on experiments with the initial mask set, to have a chance to correlate measured performance with a correct modeling of the structure as-fabricated. Indeed, the rise in receiver temperature above 340GHz is fully accounted for by the as-fabricated tuning structure. A corrected design is under way and should be ready by the time the process parameters have converged.



**Figure 15 DSB performance of two selected junctions (low output capacitance type 2). The horizontal line shows the ALMA specification for the noise of a Band 7 DSB front end. The noise temperature shown is integrated over the full 4-8GHz IF bandwidth**

The performance across the IF bandwidth has been improved over that previously reported (Figure 16). The performance shown is *without* an IF matching circuit. The structure of the mixer includes a provision for a shielded microstrip matching circuit, which is at present just a 50Ω line. There is therefore a potential for improvement in that respect.

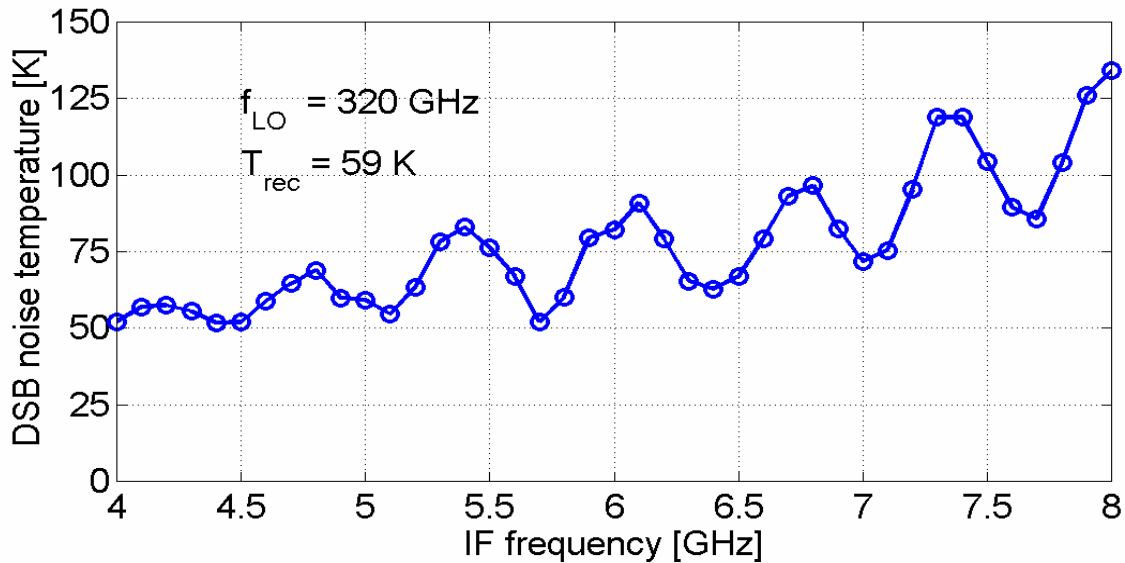


Fig. 16 Performance across the IF bandwidth for a unit DSB mixer, low output capacitance type 2, without IF matching circuit

### Type 0 mixer chips

These mixer chips were first available and were used for initial developments. Their relatively high IF output capacitance (1.1pF) requires an output matching network. After some work and iterations, a network has been designed and tested, such that the measurements are in reasonable agreement with modeling. Although this chip is not the baseline of our development, that work improved our understanding of some practical aspects of the realization of a matching network, that will be valuable when we will design a new matching network for the type 2 mixer chip.

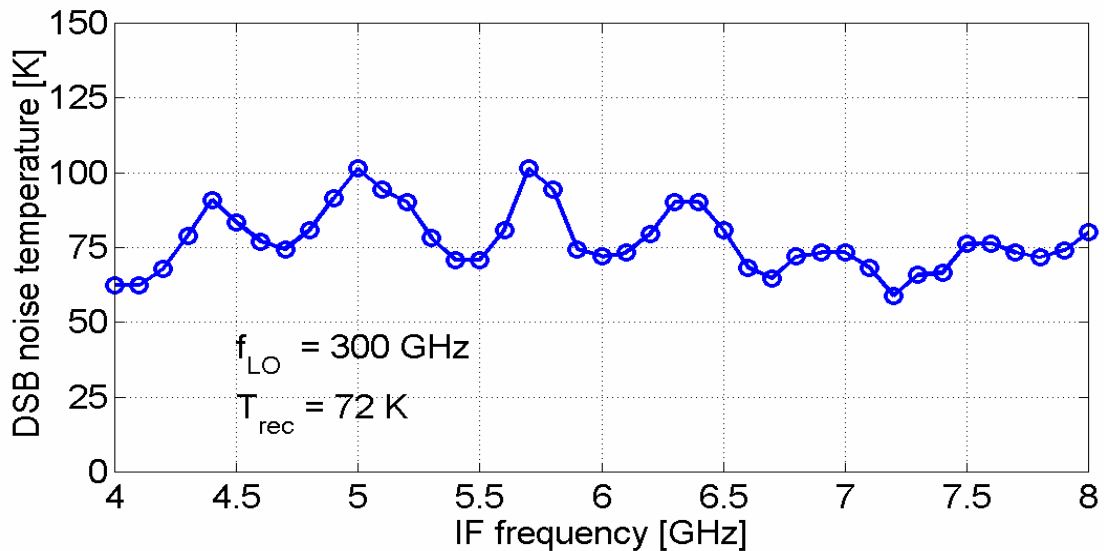


Figure 17: Performance of the type 0 mixer chip across the 4-8GHz IF bandpass, with the last iteration of the IF matching network. The flat IF response is achieved at

the cost of a slight degradation of the overall performance. That chip is no longer our baseline for development

## 2SB mixer assemblies

The two selected DSB unit mixers were assembled with the RF quadrature hybrid to constitute a 2SB mixer that was tested. That work was delayed by cryogenic problems, and it is only recently that we obtained the first 2SB results using the type 2 chips. The results are shown on Figure 18. It is interesting to note that the (average of) SSB temperatures are, for the same LO frequency, twice the DSB value, just what is expected from elementary theory. The steeper rise of the USB noise curve (relative to the LSB curve) at the high end of the band is consistent with the mean signal frequency being 12GHz higher (the frequency axis is LO frequency).

The 2SB experiment is very recent, and only one measurement of image rejection could be made at the time of writing. At 279GHz LO frequency, it was found:

$$\begin{cases} \text{USB channel: } G_L / G_U = -14.2\text{dB} \\ \text{LSB channel: } G_U / G_L = -33.1\text{dB} \end{cases}$$

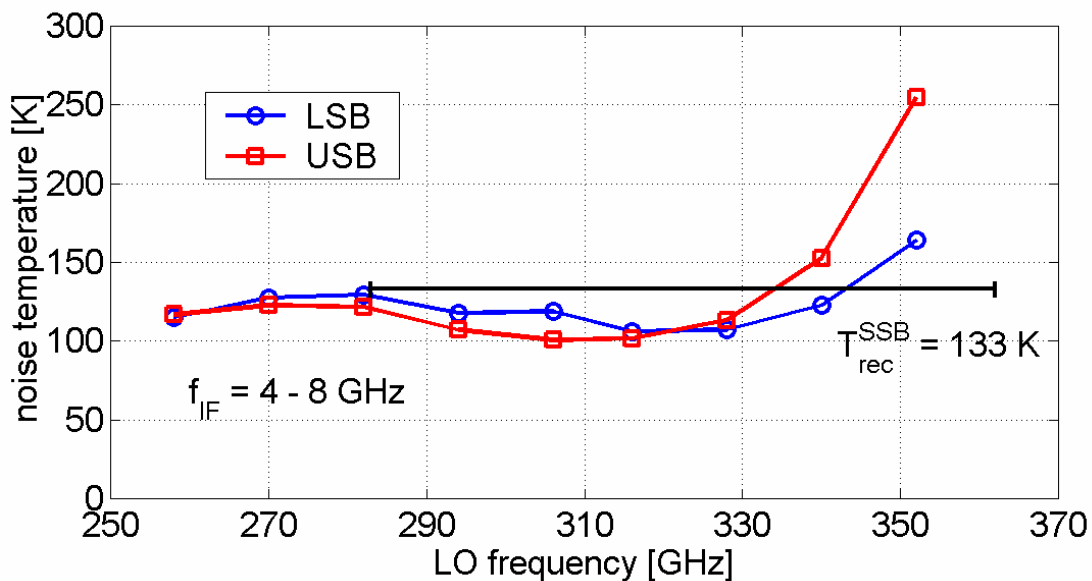


Figure 18: First 2SB results with the type 2 mixer chip. Noise integrated over the full 4-8GHz IF band Three known issues that affect the performance are being addressed: a) junction resistance too high; b) a design fault; c) no IF matching network for the time being

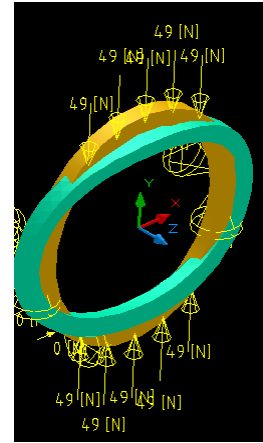
## Cartridge

Work on the cartridge, that had slowed down due to the manpower shortage following S.Claude's departure, is now normally staffed following the hiring of Sylvain Mahieu.

## Cartridge design

The definition of the optical path and of the reflecting surfaces has been re-done from scratch, both to have a good end-to-end design assurance, and to implement small improvements that result from the physical optics modeling work performed at Cambridge.

The interface of the 2SB assembly to the cold optics, previously planned to be on the outer surface of the horn, was found to be a potential source of mechanical failure. A new interface to the quadrature hybrid was defined and retro-fitted to existing hybrids, so that they can be used in the cartridge prototype.



An FEA analysis of the polarization splitter frame has been performed to ensure that its deformation under the tension of the wires stays within the tolerance budget (see at right). An alternate splitter technique (metal mesh on a thin foil) has been proposed by QMC; both will be tested at the prototype stage.

The contract with our mechanical design subcontractor (ERIA) for the 4K optics and supports has entered the final phase on 23<sup>rd</sup> June '03, and should result in production drawings in the first week of July '03.

We have defined a draft wiring plan that accommodates the 300K interface for B&C, defined by W.Grammer and J.Effland.

## Cartridge test dewar

Initial testing after delivery showed poor vacuum. Special flanges had to be machined to substitute to suspected leaking parts. Several leaks were found and corrected one after the other, gaining an order of magnitude in leak rate at each step. Recently, the cryostat was instrumented with temperature sensors and a cool down has been performed. Final temperatures reached:

Stage	Temperature
1	51.44 K
2	11.65 K
3	4.25 K

The third stage temperature is higher than expected; this will be investigated.

## SIS laboratory

During the last 8 weeks important new equipment such as the laser interferometer stage and the ICP etching equipment have been commissioned and currently undergo process optimization tests. A prototype band 7 device version is currently in fabrication. New personnel (1 technician) that was hired for the ALMA project has been trained.

## Miscellaneous

A safety audit has been conducted in the receiver laboratory. The BWO that has been purchased in Phase 1 requires special attention because its cathode supply reaches up to 4 kV. A test box has been built, that is substituted for the BWO head to test the safety shutdown of the power supply. A special audit by an external expert is planned 1<sup>st</sup> July '03. A collaborative document sharing system has been installed by IRAM's computer group and it will be put into use in the near future.

### Band 9 cartridge (ALMA Work Package: 4.190)

#### *Netherlands Research School for Astronomy*

##### -Mixer related activities

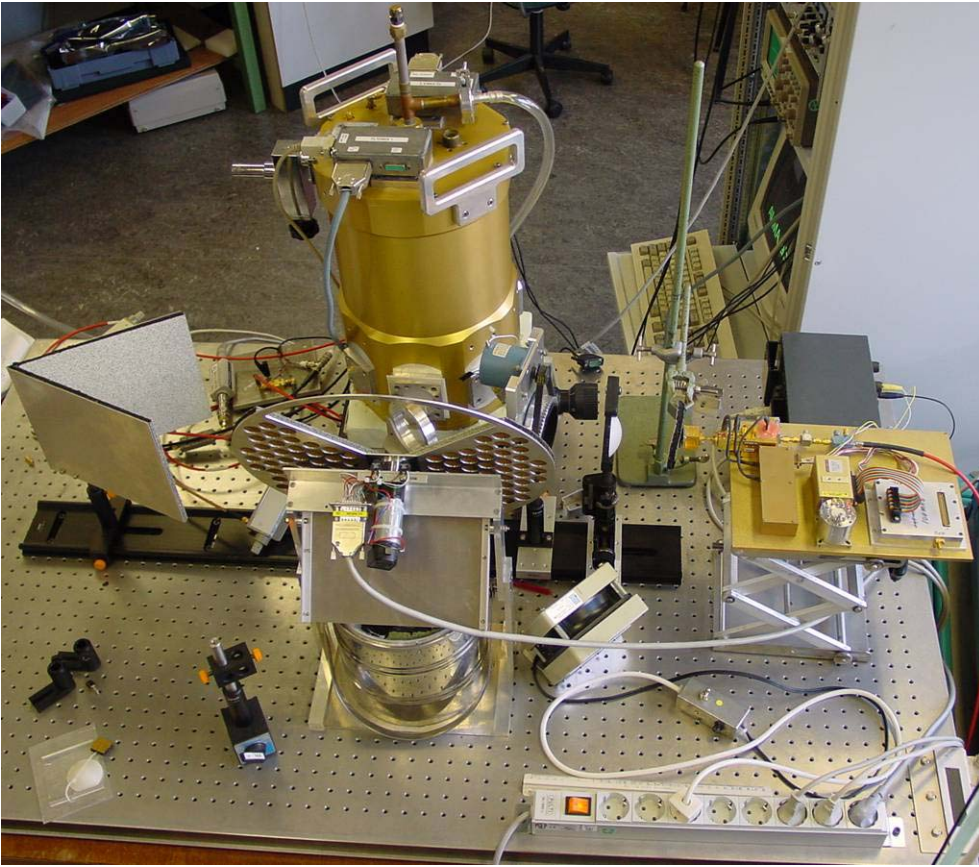
The design of the mixer backpiece has been changed to obtain a wider IF bandwidth completely meeting requirements. With this revised design it was proved that the achievable IF bandwidth is in excess of 4 – 12,5 GHz. The upper frequency is set by the performance of the isolator whose bandwidth does not extend beyond 12,5 GHz. Four cryogenic 4 - 12 GHz isolators were ordered from Pamtech. Delivery of these units is expected in August / September '03. Contact with a Russian supplier of these isolators, Domen, has so far not been successful and more attention will be given to improving this relationship. This to make sure that a second source of these critical components is available.

New SIS junctions, provided by DIMES, with NiTiN layers were tested. The results were good.

##### -Automated test set-up

The mixer test set-up (Figure 19) has been automated to a high level. The heterodyne measurements can (after installation and cool down) measure all relevant mixer data within 2 hours fully automated. Before, this would take a few days with someone permanently overseeing and controlling the manual test set-up. Also the temperature stability measurements are now fully automated.





**Figure 19 Band 9 automated mixer test set-up with pre-prototype local oscillator provided by NRAO/CDL**

-Cartridge test cryostat

As reported before lab infrastructure at SRON had to be changed (heavier duty power lines, drilling holes through the concrete wall, etc) to accommodate the cartridge test cryostat. Finalizing it appeared to take longer than expected. Quite some work on temperature sensors, soldering etc appeared to be necessary. The first cool down on June 14<sup>th</sup> showed an even better performance than expected. The 4 K stage cooled down to 2,5 K in about 6 hours.





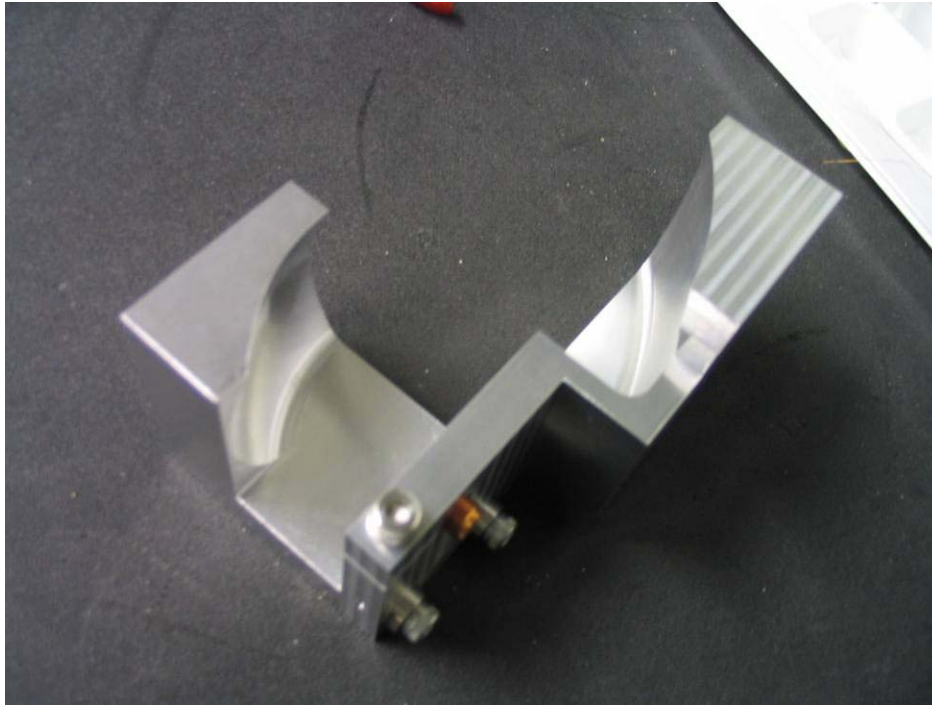
**Figure 20 Cartridge test cryostat provided by NAOJ**

-Detailed mechanical cartridge design

It is intended to fully contract out the detailed mechanical design, including preparation of engineering documentation, of the Band 9 cartridge completely to the company Mecon. A first, limited, contract was agreed to study the task and make a plan for this activity.

In May, as a result of this initial contract, Mecon provided a plan including quotation for the prototype phase until the end of 2003. This plan was split up in 4 workpackages. For the first workpackage, the optical part, an order was given to Mecon.

The design strategy is to design the mirror system so that as many mirrors as possible in the optical chain can be made out of one aluminum block. The reason for this is to minimize the amount of components and avoid elaborate alignment of mirrors. To prove the concept a two mirror system (Figure 21) was designed and manufactured at the beginning of May. A beam pattern measurement showed that the performance was quite good. A few small errors were discovered, which have to be corrected. But the concept for making the 4K mirror set (5 mirrors) out of two blocks, based on CNC techniques seems to be feasible.



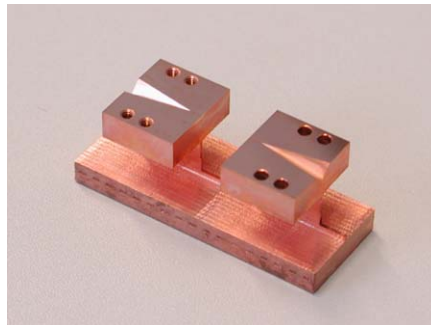
**Figure 21 Band 9 2 mirror proof of concept**

-Industrialization of mixer:

Backpieces. In order to complete the industrialization of the manufacturing of backpieces a few people at the company WITEC worked for two weeks continuously on the task. As a result of this activity, 10 backpieces have been made. Although they still have to be checked at NOVA, it can be stated that this component is now industrialized. Backpieces with even smaller cavities (for higher bands) can also be made.

Diagonal horns: Witec can now also make Band 9 diagonal horns (figure 22) on order. These are very suitable for LO horns and it is being investigated if they can also replace the more complex corrugated horns used in the feed system.

Industrial quotes for both mixer backpieces as well as diagonal horns were received.



**Figure 22 Production of diagonal horns using split block technique**

NOVA placed an order for a precision alignment and mounting set-up. It consists of a stable frame, which holds two microscopes, a work holder, two micromanipulators and a computer display. One microscope has a digital camera. A computer controls several functions like image processing. This set-up is an important tool for inspection of the backpieces and precise mounting of SIS junction in them. This set-up is a major step towards the series production of mixers.

### Water Vapour Radiometer (ALMA Work Package: 4.210)

#### ***1 Cambridge Astrophysics / Onsala Space Observatory***

##### **-WVR Interfaces**

The common optics to WVR interface has been completed, excluding the detailed mechanical mounting designs.

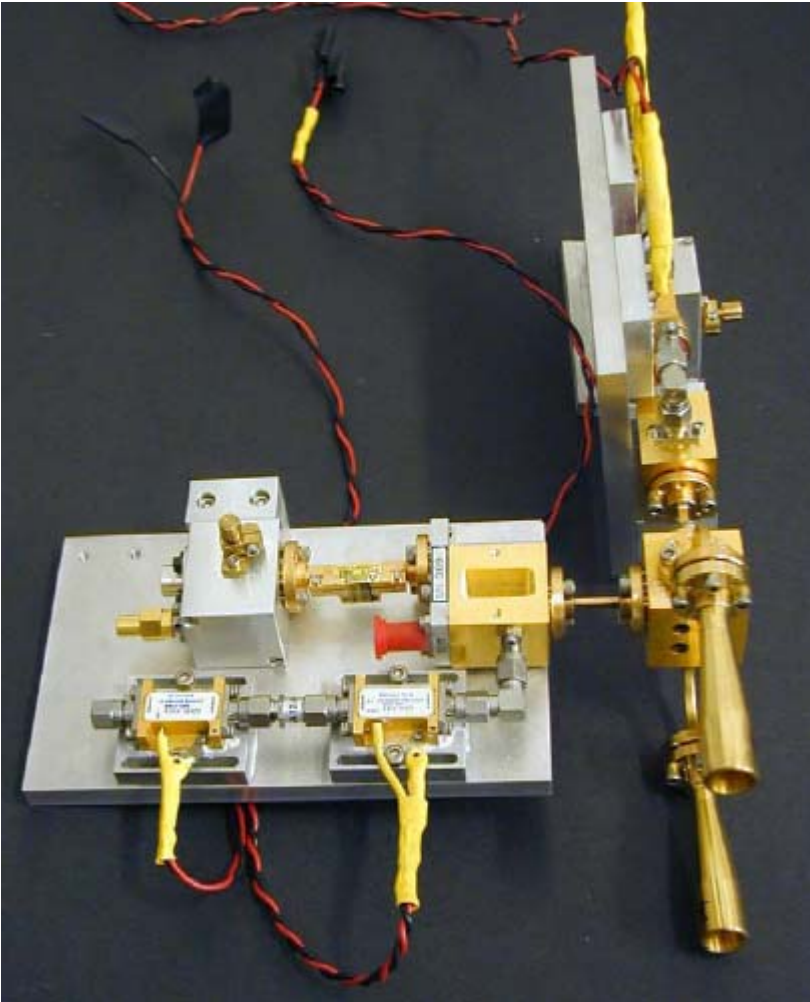
Design of the mechanical attachment of WVR enclosure to the FESS has been completed and submitted to the FE IPT for approval.

##### **-Correlation Receiver Internal Optics**

Further re-work of the internal layout has been done. EM evaluation of the internal optics using GRASP8 is in progress.

##### **-RF Sub-systems**

For the WVR feed horn a Pickett/Potter horn, including the waveguide transition, has been completed.



**Figure 23 RF/IF of correlation type WVR**

-Correlation Receiver RF/IF system (Figure 23)

System tests are ongoing, but take more time than originally anticipated. Basic characterisation of system has now been achieved.

-Detectors & Analogue Electronics

This task has been completed

-Control Electronics & embedded processor

The internal versions of hardware design, software & interfaces description have been completed. The ICD between WVR and computing was submitted by 16<sup>th</sup> May '03. An AMBS11 board was received from NRAO on the 23<sup>rd</sup> June '03. This board will be evaluated for use in the WVR.

-Cold Load

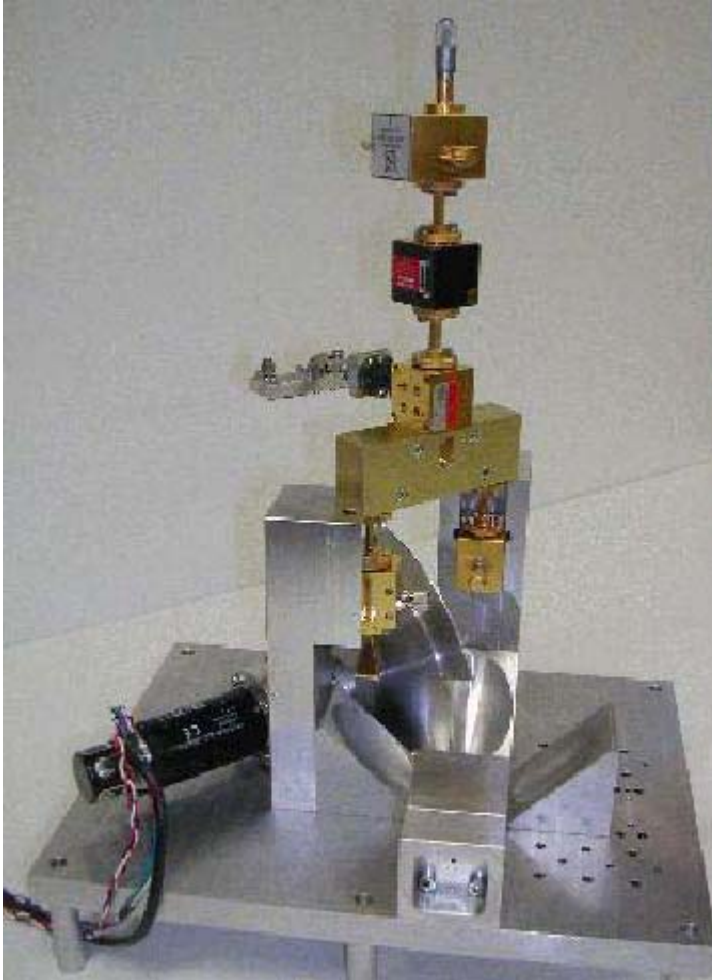
Fabrication and testing of 2 optical cold loads has been completed. An alternative waveguide design is being continued with lower priority. It is still necessary to retain the option of having a cold load inside the cryostat.

-Calibration Vane

Two units have been fabricated. Testing of these units still remain.

-Dicke Switched Front End (Figure 24)

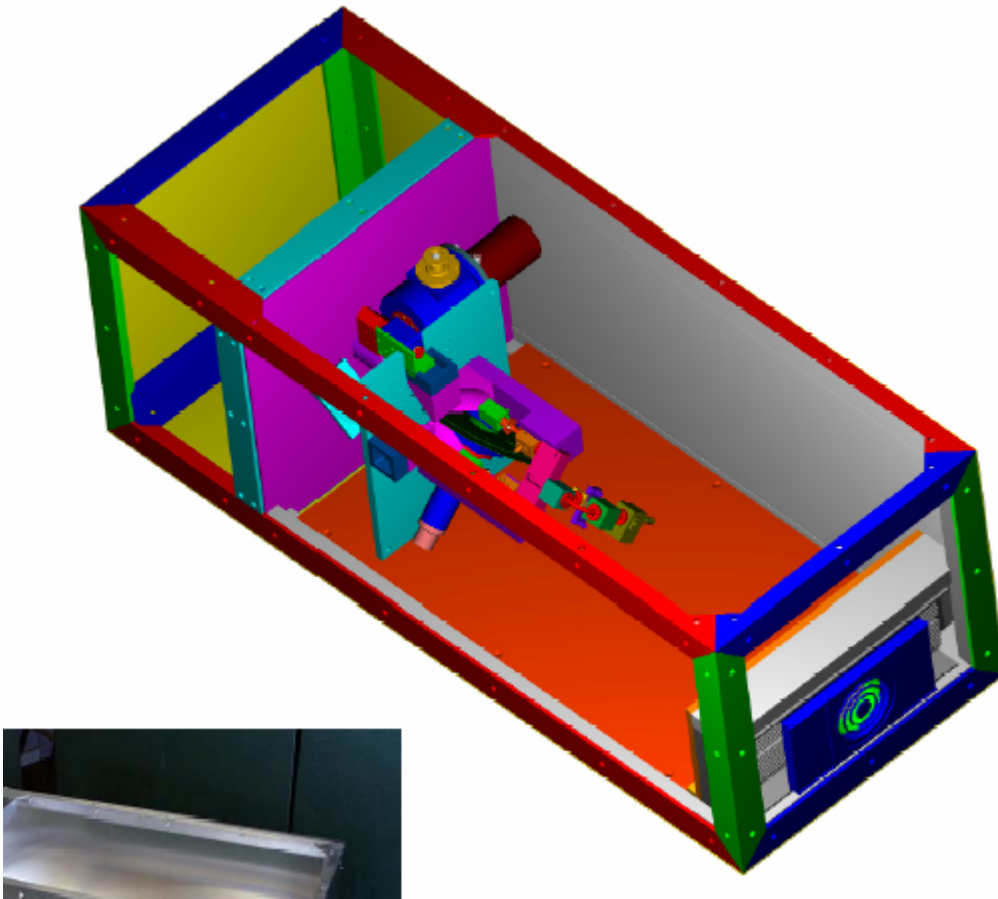
Further re-work of internal layout to accommodate optics changes. Initial system tests in progress. See comments on FE interface System tests ongoing.



**Figure 24 RF/IF of Dicke switch type WVR**

-Enclosures & Thermal Stabilization

Preparation of detailed drawings is ongoing. Tests of temperature regulation on a mock-up are underway. Construction of one frame has been completed and a second is in progress. One enclosure (Figure 25) has been shipped to CA by OSO. The second enclosure stays at OSO, insulation work remains.



**Figure 25 WVR enclosure**

-Competitive testing

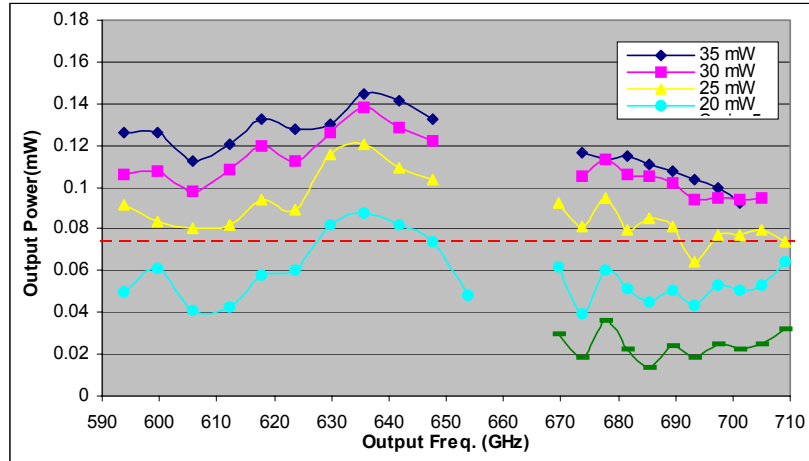
A list of tests and test equipment needed to compare the two radiometer designs was agreed at a meeting on the 24<sup>th</sup> of June '03. Planning of those tests is continuing.

First Local Oscillator (ALMA Work Packages: 4.250 / 4.258)

### ***NRAO Central Development Laboratory***

Pre-prototype local oscillator chains that will assist the various cartridge groups in their RF tests have been delivered. Final frequency multipliers for bands seven and nine have been delivered to the NRAO by the commercial supplier. The Band 9 cold frequency multiplier is the most technically challenging and is a critical component. The latest results are shown below and indicate that this particular design is close to meeting the specified performance of an output power of 70 microwatts for a pump power of 20 mW when operated at room temperature. In our application the multiplier will actually be operated at about 90K and at this temperature the efficiency improves by about 50%.

## BLK 29, 5++hi, A

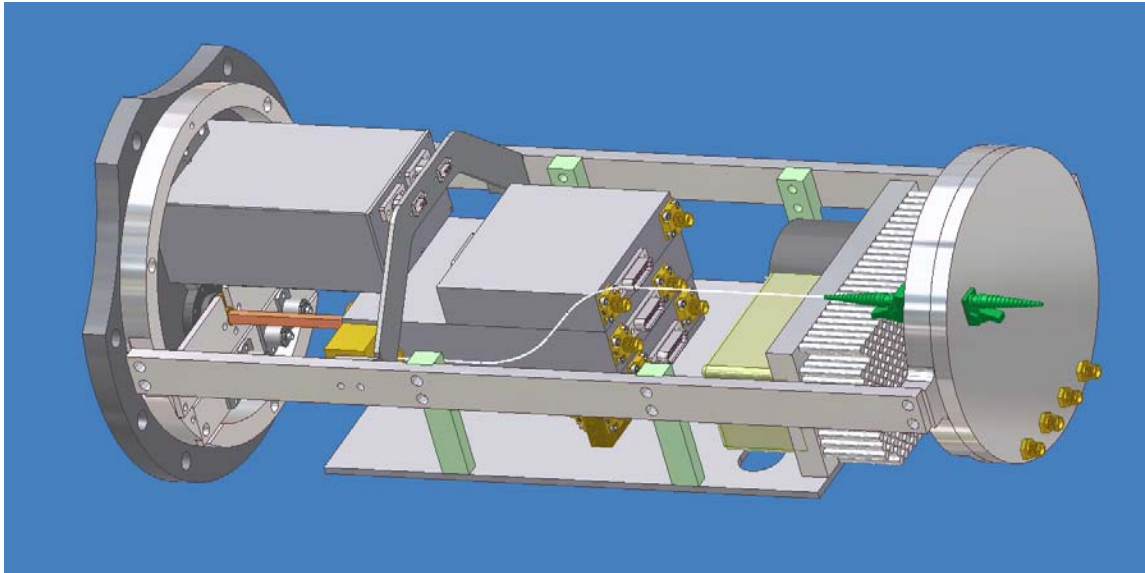


- 5++hi, 0.9 um circuit type needs low input power for output saturation
- When input power= 25 mW, the output power is > 75 uW for the whole band. (The dip @693 GHz for 25 mW sweep was because the input at that point was only 23 mW)

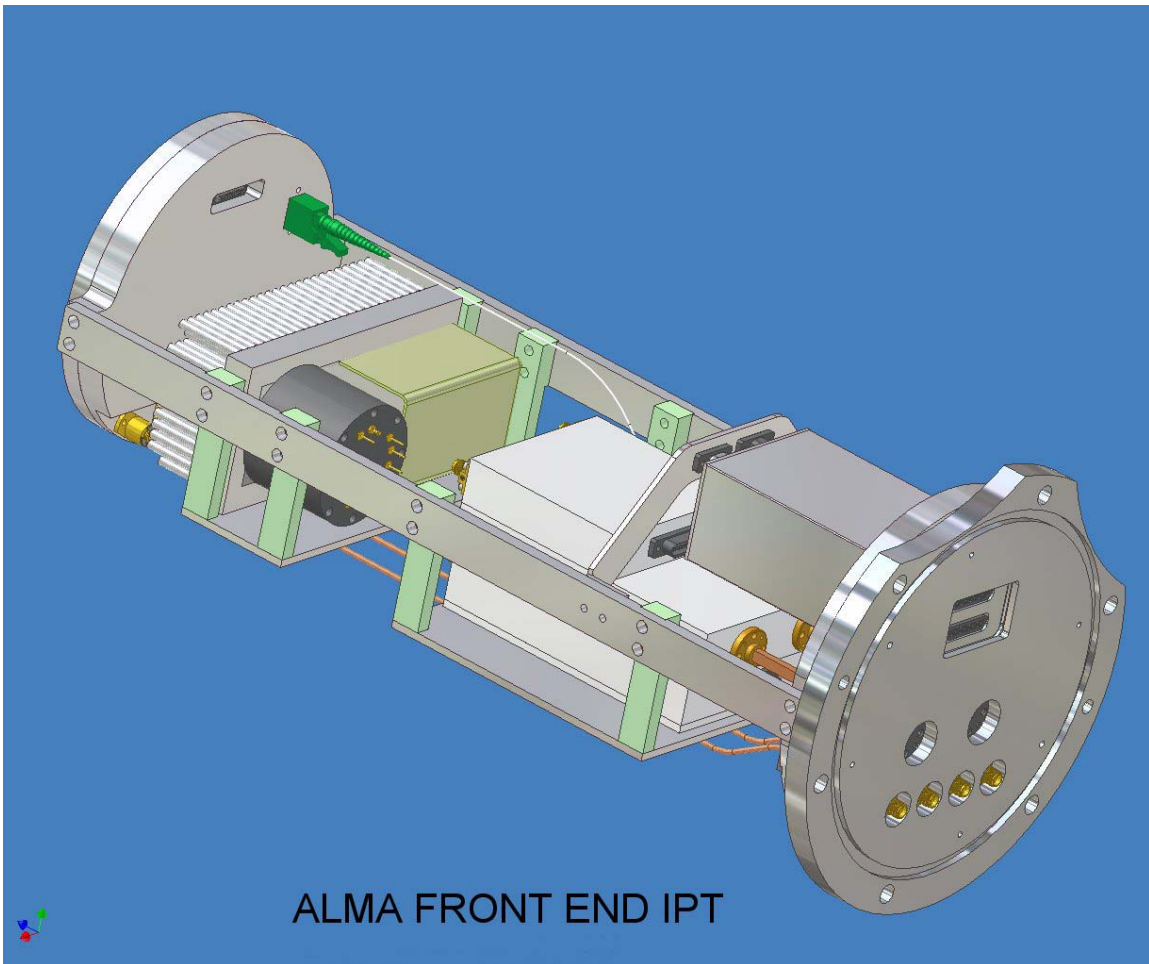
**Figure 26 Band 9 quintupler performance vs. frequency**

A Band 9 device is undergoing RF tests at SRON to determine the actual RF power requirements. Work continues laying out the cartridge-specific LO components and a compact design that fits the smallest cartridge (Band 3) is illustrated below. Thermal tests indicate that with the cooling available to the front-end the units will not overheat. Another concern has been the possibility of YIG harmonics propagating through the system and contaminating the spectrum when integrated using a sensitive spectrometer back-end. Tests have been performed using the Green Bank spectrometer and a prototype local oscillator chain driving a low-noise Band 3 mixer. No spurious signals were seen in a 30 minute integration period. A report on these recent tests is pending.





**Figure 27 Band 3 Cartridge Layout**



ALMA FRONT END IPT



## 2.5 Back End (BE) IPT

### Data Transmission System (DTS)

Circuit design of Revision B of the Digital Formatter circuit card was completed and is in the process of being assembled and tested. One copy of Version A of the formatter card was sent to Jodrell Bank Observatory (JBO) for use in its tests of the optical transmitter part of the design. Accompanying the Formatter Board are two other circuits, a board to house the Monitor and Control (M&C) and Power Supply and a “mother” board to interconnect the DTS with the University of Bordeaux sampler card. Both boards are in various stages of completion.

JBO has received the laser transmitters and photodiodes for 2 pre-production prototypes. The daughter board containing the laser diode has been designed, verified and production started (Figure 1). A prototype laser control board is under test (Figure 2). So far the design has proved to be satisfactory, with delivery expected in October. The design and prototype for the photodiode receiver boards have been accepted with production due to take place later in the summer.

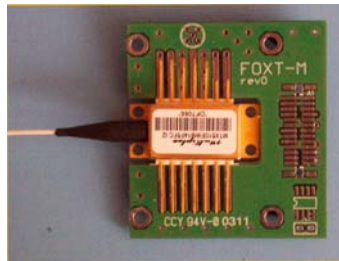


Figure 1. Laser on daughter-board

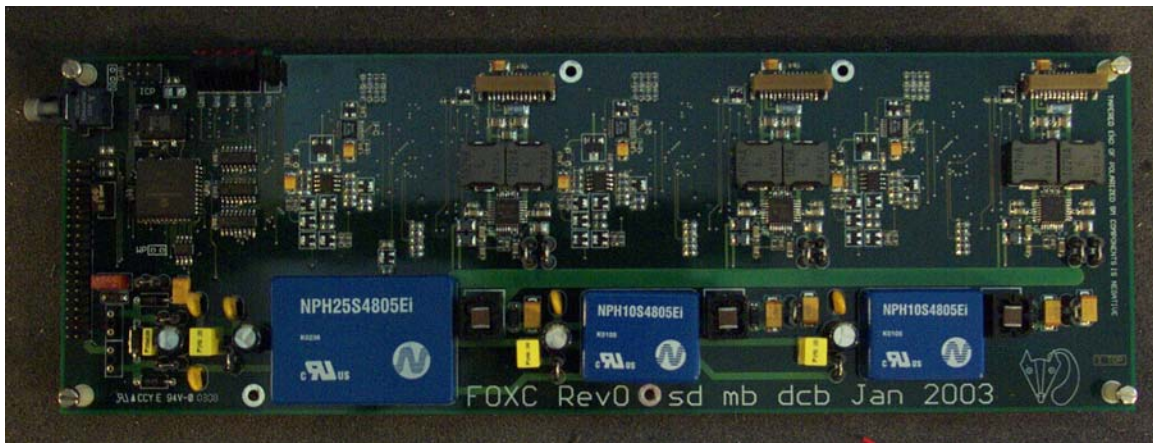


Figure 2. Laser Controller Board

The design of controller boards and hardware for the Mux/DeMux (Figure 4) and EDFAs (Figure 3) has been started with completion expected after the summer. Laboratory tests on sample devices have been undertaken. The EDFA is satisfactory, however lab tests show that a better specified Mux/DeMux is required. This is readily available and not a problem. Delivery of these to the system integration site will be in early 2004.



Figure 3. Erbium Doped Amplifier (EDFA)



Figure 4. Mux/DeMux

A report has been completed on the attenuation fluctuations in a single mode Fibre. This found that the maximum change in attenuation over a 2-km fibre link installed on the Lovell Telescope was 0.14 dB. No change was seen when the telescope was moving. This attenuation change is not significant enough to effect the digital transmission system.

Following ALMA week, a document has been written to establish if the EDFA unit can be removed under certain circumstances. This was in response to possible changes in link length specification and the possibility the optical switch may be removed from the design. It was found that the EDFA could be removed, when an avalanche photodiode is used at the receiver end. However the design allows no flexibility over and above the 6 dB start of life margin. It is likely the EDFA will remain in the design, given that the baseline specification will remain valid at least until some time after the pre-production prototypes have been built and tested.

The data link market is moving rapidly into the 10 Gbps arena, so that now a  $\frac{1}{2}$  transponder is available that would combine the Digital Formatter, 3 fiber optic transmitter cards, and the laser controller board into a single circuit card. Even the multiplication from 625 MHz to 10 Gbps is done on the  $\frac{1}{2}$  transponder. This device may

therefore prove to have advantages over the current design, and we plan to investigate the use of such devices further.

At the receiving end of the data link, printed circuit boards for Revision A of the Digital Deformatter are scheduled for delivery this quarter. Each Digital Formatter board has 3 channels, one for each bit from a given sampler. Synchronization or “de-skew” of the 3 bits, an essential requirement, is addressed with FPGA (Field Programmable Gate Array) software under development.

Specification of the fiber optic cable awaits an engineering study of direct burial vs. conduit and single vs double armor for direct burial. Negotiations over which IPT should perform the study are being conducted.

A design of the fiber management plan sufficient to plan conduits and space in the AOS Technical Building is nearly complete.

Modules ready for testing are scheduled for October.

### **Digitizer Sampler, Demux, and Clock**

New packaging (VQFN: Very thin profile Quad Flat Non-leaded) performed by STM, Inc. on naked sampler chips has allowed us to progress with our sub-contractor on the designing of industrial sampler PCBs. We expect to receive by the very end of June our latest 3-bit sampler design (1.5 W dissipation instead of above 2 W per chip in the previous design) for oscilloscope measurements.

A joint meeting with STM has allowed us to understand and define how to perform sampler life tests (Operating Life Tests and High Temperature Bias tests) before entering the sampler production phase. These tests and subsequent analysis will be completed by mid-2004 but all details concerning reliability boards, sampler modules, new sampler chip design consistent with STM requirements, etc must be prepared during the second semester of 2003. The layout for the new sampler design required for life tests will be sent to the foundry by December 2003.

A total of 50 Demux chips (1 ASIC per sampler bit) have been received from the foundry. These naked chips will be bonded on board through an industrial process still in development with Solectron-France. Testing of our first demux design (design of January 2003) on board is scheduled for the beginning of July; a full test procedure for this digital ASIC has been prepared.

Microscope inspection of received 50 chips shows that for 10 chips metal layers have come unstuck. These defects are under investigation with STM and can be due to minimum protection of the bare chips during transport, insufficient protection at the sawing stage, etc.

A newer design of our demux chip has been performed and reviewed internally. The result is a drastic improvement of the heat dissipation now at the level of 1 W with the hope to be significantly below 1 W. After the test results of July for our first design will

have been analyzed the newer design will be further consolidated to go to the foundry in the Fall.

Several technological studies have progressed for the complete digitizer assembly: substrate interconnection, thermal dissipation, naked demux die bonding and protection.

Detailed design of the Digitizer Clock has started at IRAM and key components have been ordered in sample quantities. Most of them are in house now. The only unknown block, the double I/Q modulator, has been prototyped to evaluate its actual performance (Figure 5). Measurements have been taken on the breadboard. They are better than expected and largely exceed the requirements.

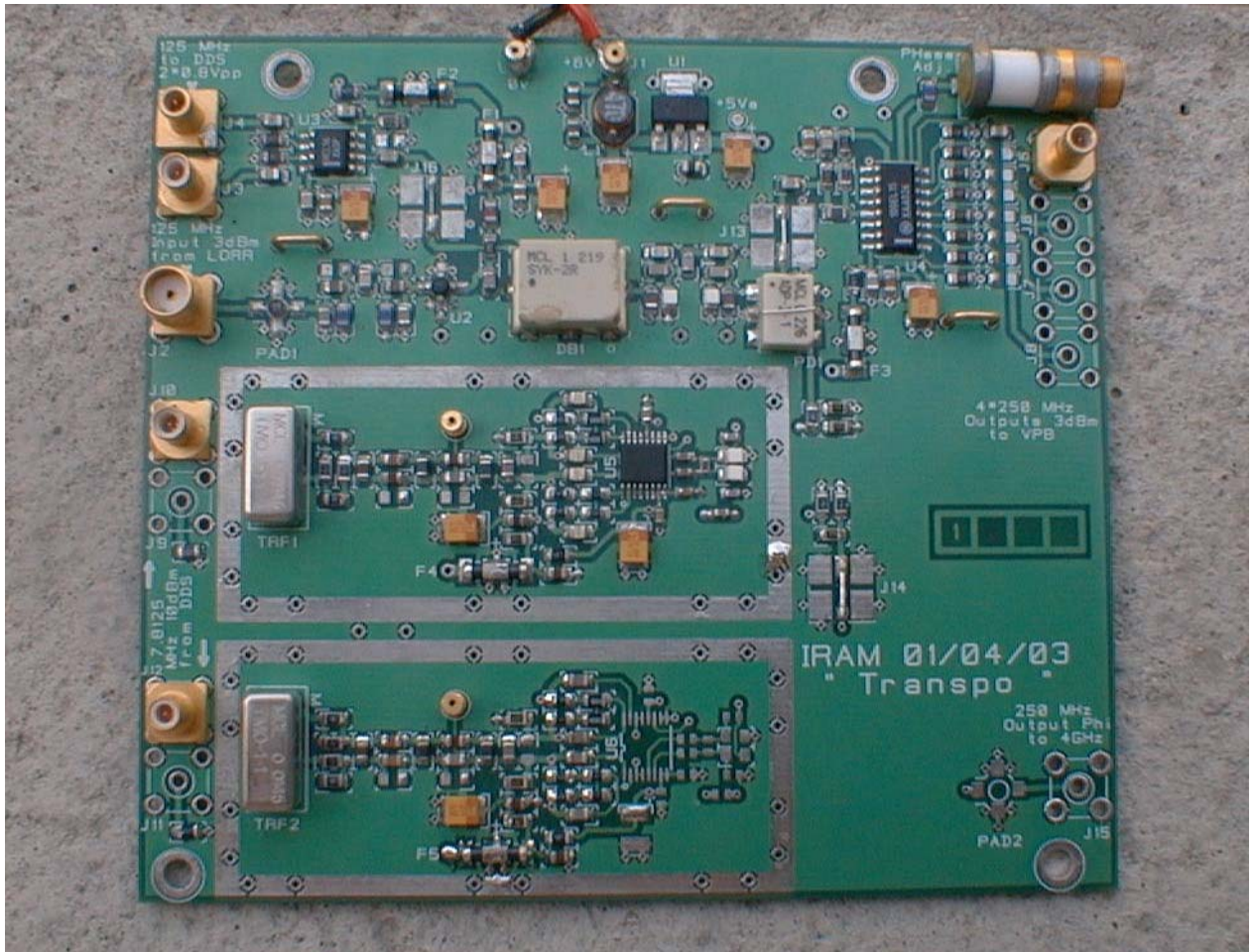


Figure 5. View of the double I/Q modulator evaluation board

A prototype of the microwave section including VCO, coupler and times-4 distribution has been designed. The amplitude and phase matching among the 4 outputs are excellent.



The mandatory use of an AMBSI module for clock control creates additional and hardware complexity that can probably be lived with, but which requires some extra integration work. An AMBSI card has been requested from NRAO.

The recent ALMA week has allowed us to fix many practical details of the digitizer clock module and to refresh the antenna electronics block diagrams as well.

### **IF Downconverter**

Budgetary estimate quotes on the integrated version of the downconverter show a potential savings during production of \$2M over the baseline plan for “connectorized” versions. A draft Request for Quote (RFQ) for an outside vendor to produce 3 prototype integrated modules is being reviewed by the System Engineering IPT and will be released to the Purchasing Department for placement of the order after the review and corrections are completed.

### **Total Power Backend and other ATF support**

The Front End IPT at Tucson is testing the Total Power Back End (TPBE) with the evaluation receivers in preparation for performing radiometric holography tests on the Vertex RSI ATF antenna later this year. A second TPBE is ready for testing the Acatel ATF antenna.

### **DC (Direct Current) Power Supplies**

DC power distribution for BE and LO (Local Oscillator) modules at the antenna and for LO modules at the AOS (Array Operations Site) Technical Building is planned using a 48 VDC switched supply and several regulators to provide voltages of +6.5 VDC,  $\pm 16.5$  VDC, +24 VDC. Additional voltages and tighter regulation can be provided in the individual modules. Spectral tests on the 48 VDC supply show low level RF emissions from the switching action at 125 kHz and 300 kHz. The emission frequencies can vary slightly with load, but in any case can be filtered out sufficiently for BE operation. FE (Front End) IPT has elected, however, to use separate linear supplies to avoid any interference from the switching function.

A prototype of the power supply design is being used successfully for the TPBE described earlier.

### **Module and bin hardware**

The BE IPT has commissioned construction of RF(Radio Frequency)-shielded hardware for housing the various BE modules (Figure 6). Special care was taken for the bin containing the DTS transmitter and sampler modules because of the high levels of RFI (Radio Frequency Interference) anticipated. Hardware is scheduled to be ready by September to begin final assembly of prototype modules. Selection of the design was predicated on meeting requirements of the AOS RFI Plan and for reliability.

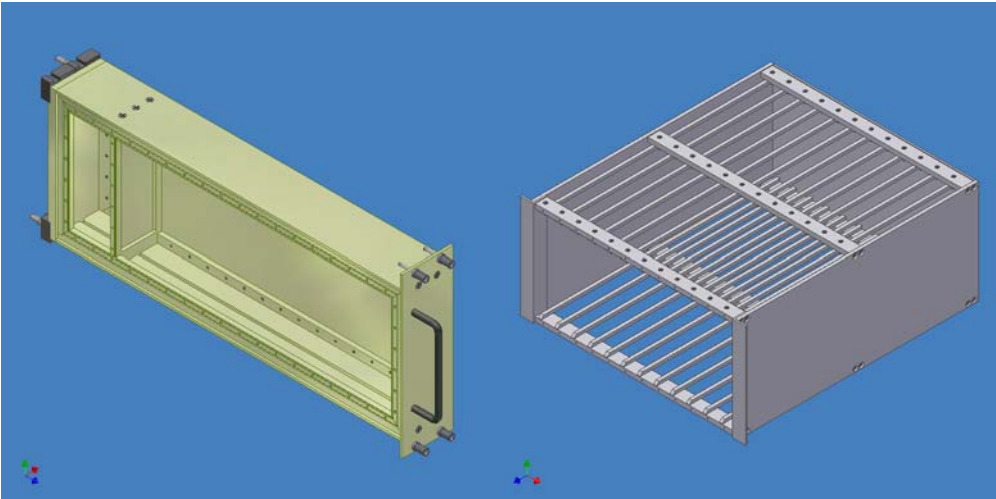


Figure 6. Module Housing and Bin for BE and some LO modules

### **Test fixtures**

Test fixtures for proving the prototype module designs independently of M&C (Monitor and Control) software are essential for development and later on for repair during Operations. A sophisticated test fixture planned will verify data integrity at the bit level for the DTS. Another special test bench with control and display software is planned to verify full functionality of 3-bit samplers. Other tests are being planned using a visual test software package by National Instruments called LabView. Computer control of tests will permit documented characterization of modules and components over a variety of operating conditions. Test fixtures and software are scheduled to be ready for use by November 2003.

### **Documentation**

Interface Control Documents (ICDs) have been initiated to define the interface between the BE IPT and the following elements: Correlator, Front End (FE), Site Array Operations Site (AOS) Technical Building, Site fiber optic array, Antenna, and Computer. In the case of the Front End ICD, two documents are planned, one for BE to FE and the other for LO (Local Oscillator Sub Group) to FE. The Computer ICD consists of multiple ICDs, one for each CAN (National Instruments proprietary serial bus) Node on the Monitor and Control (M&C) interface. LO and BE ICDs are combined except for FE and Computer IPTS.

The Computer ICDs are currently delayed for the fiber optic, digitizer, demux, and sampler clock modules. The two Site ICDs are delayed by questions over the fiber optic specification and fiber management design. Other ICDs are scheduled for delivery to the SE (System Engineering) IPT in July.

### **System Integration**

The BE IPT plans to address the Level 2 milestone to provide modules for System Integration in 3 phases:

Phase I: Provide 1 downconverter, 4 samplers with demux and clock, and 6 DTS channels per ATF (ALMA Test Facility) antenna on 4 January 2004. Tests of hardware and software can commence at that time using a signal generator to simulate the front end. The test correlator is scheduled to be available for Phase I. Although 4 IF (intermediate frequency) channels will be available on production antennas, only 2 IF channels will be tested on the ATF antennas because of limitations of the evaluation receivers. It may be necessary to divide Phase I into two parts; the first to test the equipment for only one antenna and the second to test both at once if delays occur in equipment delivery.

Phase II: Install the equipment from Phase I on the ATF antennas after the antenna evaluations are complete. Evaluations are scheduled to end by April 2004. The equipment can be tested with the evaluation front ends once antenna installation is complete.

Phase III. Test the design complete with EDFAs (Erbium Doped Fiber Amplifiers) and optical multiplexers starting by June 2004. Testing is scheduled to culminate in first fringes by September 2004.

The current plan calls for the BE CDR by May 2004 and the Production Plan by September 2004. A request to delay both has been forwarded to allow time for testing prototypes before production decisions are made.

## 2.6 Correlator IPT

### Prototype 2-antenna correlator

The prototype two-antenna correlator was completely assembled and integrated testing verified operation of all circuit cards. A few of the signals sent from station bin to correlator bin are not quite as robust as the great majority, and this will be investigated in order to get the error rate on each line down to zero. A wiring error on the station bin backplane was found which must be corrected but does not hinder system checkout. Correction of this error has been postponed until it has been determined whether the enhanced FIR filter card will be used, since a small change in the power distribution may be required for the enhancement.

Construction of an optical receiver card simulator began. This card will substitute for the actual optical receiver card, and can provide either a standard pseudo-random pattern for interface verification or actual samples of a noise source for long-term integration testing.

Firmware development for advanced operation modes continued. Most of this is required in the LTA card, including:

- (1) Special adder tree modes required by the two-antenna prototype system;
- (2) Support of the operational environment of the two-antenna prototype system.

Most activity is now in the software area, since most hardware checkout is complete. This is concentrated on operational modes which will be required for the test interferometer.



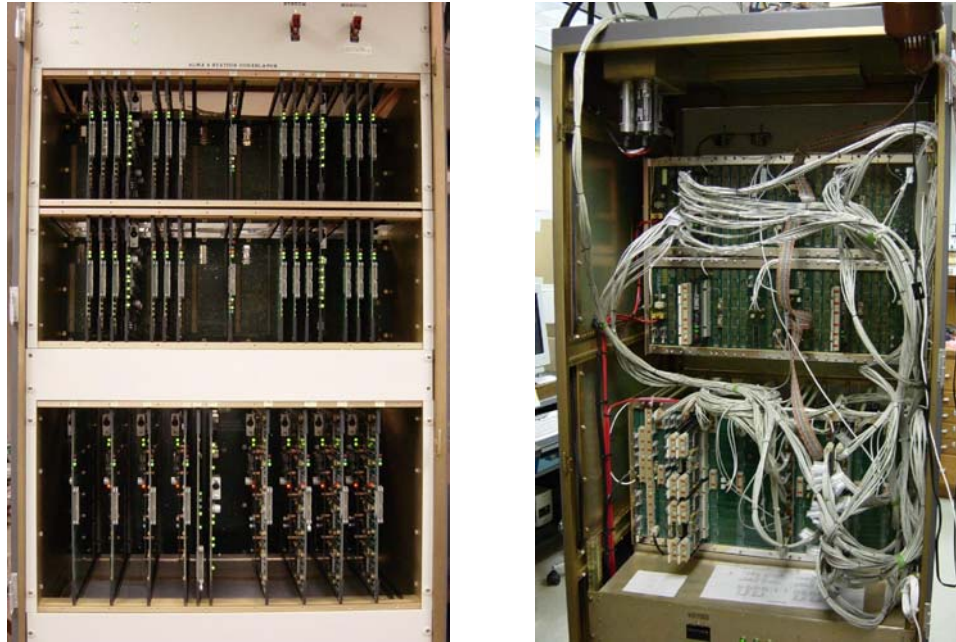


Figure 2.6.1. Front (left) and rear of prototype 2-antenna correlator rack showing card cages, cards, backplanes, fans, and power supplies mounted.

### Enhanced filter card

Further study and design of a possible enhancement of the baseline correlator performance has been done. By substituting an advanced filter card with multiple simultaneous output bands for the single-band output present filter design, it is possible to achieve much greater frequency resolution in the widest bandwidths, or to analyze several narrow bands simultaneously with even higher frequency resolution. Extensive work has been done on selecting the most efficient of several alternate algorithms to perform the desired functions. The architecture selected employs 32 128-tap filters for total of 4096 taps. The filter stage is followed by two matrix multiplies and then a cosine transform. The net effect is up to 32 identical filters spaced evenly across the 2 GHz band. Xilinx FPGA chips which are available at present have been selected, and preliminary designs have shown that the required functions will fit on a card of the present dimensions. Power predictions show a slight increase in power consumption, but it remains within acceptable limits and is actually less per chip (there are more chips on the new board).

Simulation of the algorithm is underway. The intent here is to verify the algorithm before committing to final board design and prototype construction. With the cost savings made possible by converting the filter FPGA to a custom ASIC, the cost of the enhanced filter card is expected to be nearly the same as for the present single filter card.

Intensive discussions among all members of the correlator IPT who attended ALMA Week in Victoria, BC showed that it may be possible to use the advanced 2GC filter design in the baseline correlator (see further discussion in section 2.6.4).

### **Schedule**

The goals for March-May 2003 were:

- (1) Complete assembly and individual test of all prototype correlator circuit boards;
- (2) Perform the first end-to-end testing of the entire prototype correlator;
- (3) Complete the design study for the enhanced filter card and recommend a course of action for implementation;
- (4) Based on experience with building the prototype correlator, re-estimate the schedule and cost of the complete 64-antenna baseline correlator.

All these goals were met with the exception of (2), which is now expected on 30 June 2003.

The goals for June-August 2003 are:

- (1) Complete hardware checkout of the two-antenna prototype correlator;
- (2) Write preliminary version of firmware needed for the test interferometer;
- (3) Complete design and simulation of the enhanced filter card;
- (4) Hold a Critical Design Review.

### **ALMA Second Generation Correlator (2GC)**

Following completion of the 2GC System Architecture (see proposal in ALMAEDM/Correlator IPT site) and submission of the "ALMA 2GC System Requirements" document, our tasks were focused on: correlator chip study (optimum 3-bit multiplication and implementation optimization); FIR filters conceptual and implementation studies; and interconnect technology study. These tasks and a proposed schedule were presented during the AMAC and ASAC meetings of March and April 2003.

A report on interconnect technology has been edited. It explores what could be made for the ALMA 2GC and includes scenarios for backplane interconnections and for filter to correlator units interconnections. An overview of the components available on the market is also given.

The 2-stage FIR filter architecture is an essential part of the 2GC which offers several advantages (independent tuning of sub-bands, spectral zooming, tap recirculation, etc). Rapid progress was made on a description in Very High Speed Integrated Circuit Hardware Description Language (VHDL) of the individual sub-elements forming one FIR filter. The next step is to have a VHDL description for the whole complex FIR filter including the digital LO, and check functionality in existing FPGAs. At the same time a

number of effects have been investigated; they include: aliasing and filter roll-off; phase errors; and quantization effects in the FIR filter stages.

Alternative design study to the 'basic' 2-stage FIR filter design has begun with the goal of using less resources; in this option, the digital LO is operated at decimated speed after the first filter stage.

During the ALMA week, intensive and fruitful discussions on new possibilities offered to the scientific users and on compared merits of the enhanced baseline FIR filter and the 2GC FIR filter designs reached a peak. It has been concluded that full cooperation within the Correlator IPT on filter issues with constraints imposed by the Baseline Correlator design should prove useful in enhancing the ALMA telescope performances.

Our goals for July-August 2003 are: estimate performances of 2GC FIR filter bank as a 'plug-in' filter card for the Baseline Correlator; crude estimate of cost and schedule; and continue comparison of science capabilities.

## 2.7 Computing IPT

### General

This has been a significant quarter for the Computing IPT.

The Computing PDR panel report was made available to the project and Computing IPT management wrote a response. While important issues were raised (see 2.7.3 below), the panel felt that the PDR was well prepared and that ALMA is at or ahead of where other similar projects have been at this stage of their development. The PDR material can be found at:

<http://almaedm.tuc.nrao.edu/forums/alma/dispatch.cgi/2002pdrbackend/folderFrame/100189/0/def/870e>

The Computing IPT held its first integrated release – R0. As evidenced from its version number (0), this release was intended to test internal procedures system-wide before the subsystems start delivering significant functionality.

The first functionally significant release (R1) is due late this year. As the lead up to that we are in the process of holding our first incremental critical design review (CDR1). As the time since PDR has been short we are concentrating on items related to the R1 release.

A significant ALMA Common Software (ACS) release was made (2.1). At the same time the Archive subsystem made a first release of the Archive software for use in subsystem developments. While this is a lightweight implementation, it fully supports one of the fundamental Archive interfaces (for storage of XML entities).

An ACS course was held with approximately 30 participants. While most participants were from ALMA, there is some interest in adopting this core technology in other projects (e.g., the NRAO eVLA project).

Software support at the ATF continued. Notable in this quarter was commissioning of the holography software (control and data analysis). The holography campaign proceeded well without major software problems.

Several staff members attended ALMA week, discussing general ALMA management issues, communications, ICDs with other subsystems, operations planning, AMBSI policies, and a number of smaller items.

### Milestones

The Computing IPT Level 2 Milestones for the current, and next quarter are as follows.

<b>Milestone</b>	<b>Original</b>	<b>Current</b>	<b>Actual</b>
Preliminary Software System Design Review	2003-03-15		2003-05-08 <sup>1</sup>
Subsystem Software Release R0	2003-05-01		2003-05-16
Subsystem Critical Design Review 1 (CDR1)	2003-07-09	2003-07-25	

### **Significant Issues**

The most important PDR conclusions of the PDR Panel were as follows (paraphrased):

- Well prepared PDR; at or ahead of where similar projects have been at this stage
- The ALMA Project needs to develop an understanding of operations, and the Computing IPT needs to fold this in to their planning and priorities. This might result in reprioritization of SSR requirements. [Agree. The project has appointed an Operations Planning team, and also the Science IPT has started work on a Design Reference Mission. The Computing IPT will make whatever adjustments are necessary when these are available.]
- ALMA project needs to define clearly the steps necessary for getting to, and implementing, Interim Operations and the consequent requirements for computing support. [Agree. This has partially been taken into account for CDR1. A more complete exercise will be undertaken once the Operations Planning group has reported.]
- The interaction with AIPS++ requires careful management. Operational (Pipeline) requirements on AIPS++ need further development. [Agree. See the management changes in 2.7.4.1 below. Operational requirements on the Pipeline will be obtained this year.]
- Testing effort seems satisfactory; management will need to follow-up to ensure subsystem unit tests are in fact carried out. [Agree. We are checking on this point at CDR1].

The R0 integration showed several issues that need to be resolved for subsequent releases. Perhaps most important is the fact that the Integration and Test team need guidance from the analysis and design team and the SSR about how the system works and what the integration tests should contain.

Holography support consumed all the ATF support resources and we were not able to close out the remaining items related to optical pointing. These should be completed next quarter.

### **Work Element Reports**

All subsystems participated in R0 and CDR1. This common activity is not repeated in all subsections below.

---

<sup>1</sup> The definition of this milestone was changed from the date of the PDR meeting to the date at which the panel report and Computing IPT response was delivered to the JAO. The PDR meeting was held as originally scheduled.

### **Management (2640)**

Notable in this period were two management changes at the NRAO. First, the AIPS++ group now reports directly to B. Glendenning (ALMA Computing IPT Lead) and J. Ulvestad (Assistant Director for Socorro Operations). This direct connection to the ALMA project should be helpful in ensuring appropriate management direction towards ALMA deliverables. Secondly, D. Shepherd was appointed the NRAO Deputy Division Head Computing (ALMA). This is an NRAO appointment not affecting the position of G. Raffi as overall IPT Deputy. Shepherd, a millimeter-wave astronomer, was appointed to this position to bring direct scientific input into Computing IPT management discussions. (J. Schwarz remains as the ESO deputy to G. Raffi.)

### **Science Software Requirements (2680)**

Progress: A major effort to create test plans, led by the SSR, has commenced. The Offline test plan was developed as a first example, to be followed by Pipeline and Proposal Preparation.

Issues: European SSR staff scientist position vacant.

### **Analysis and Design (2700)**

Progress: Submitted recommendations to IPT Management, based on R0 results, to improve the testing and improve the definition of deliverables for R1. Enhanced the base Notification Channel implemented in ACS2.1.

### **Software Engineering (2720)**

Progress: Completed the transition from CMM to CVS. Python coding standards were internally discussed and final recommendations to IPT management made.

Issues: Vacant position at the NRAO.

### **Common Software (2740)**

Progress: ACS 2.1 release. An ACS course was prepared and held. The Notification Channel is now supported under Java and Python as well as the original C++.

Issues: Keeping compiler versions aligned across all development teams and operating systems (especially VxWorks) has been an issue.

### **Executive Software (2750)**

Progress: Creation of a detailed Use Case for UserAdmin. Evaluate usage of LDAP for user database (it was concluded that LDAP was relevant but since DB2 does not fully

support the protocol it would be simpler to stay with a trivial XML implementation). Staffing was completed.

### **Control Software (2760)**

Progress: Holography software commissioning. First modules (relating to antenna control) from the existing control software were ported from VxWorks to real-time Linux as part of the evaluation project. Completed hiring two new positions in Socorro (although the final staff member does not start until September). Ported Control software to use more recent ACS release (2.0, this was done before the 2.1 release). Support for lab integration of radiometry in Tucson.

Issues: Conflict between short term ATF activities and longer term ALMA developments.

### **Correlator Software (2780)**

Progress: Quadrature phase delay software has been implemented. MPI was investigated, and rejected, for use within the CDP. Staffing of the correlator software group has completed.

Issues: The FPDP interface card is faulty. The vendor has been notified.

### **Pipeline Software (2800)**

Progress: Closer integration of the heuristics and infrastructure planning achieved. Technology evaluation (ACS, CORBA) for prototype pipeline started. AIPS++ code base forked to support prototype pipeline development.

### **Archiving Software (2820)**

Progress: A new internal interface was developed to allow different underlying database technologies to be plugged in (IBM DB2 and Xindice). Investigation of commonalities with the Gemini Science Archive are in progress. VOTable extensions required for ALMA are being investigated.

### **Scheduling Software (2840)**

Progress: Implementation of simulation classes for R1 started.

Issues: Some interoperability problems while trying to use software developed by the observing tool team (not unexpected result of first integration attempts).

### **Observing Preparation and Support (2860)**

Progress: Transitioned to ACS2.1. A GUI mockup was distributed within the team for internal comment. A logging infrastructure was implemented.

**Off-line Data Reduction (2880)**

Progress: A draft discussion document on the ALMA export data format was created. Work towards finalizing Phase III (performance) of the AIPS++ tests, although the tests are not yet final.

Issues: Reorganization of the AIPS++ project (external consortium disbanded) and management changes at the NRAO were disruptive last quarter. This has now been resolved in a manner favorable to ALMA with no further disruption to the development team anticipated.

**Data Reduction User Interface (2890)**

This subsystem has been postponed for two years. See the PDR panel report.

**Telescope Calibration (2900)**

Progress: Prototypes of TelCalResults and TelCalPublisher packages implemented.

Issues: Internal Computing ICDs between Control software and Telescope Calibration are not entirely consistent. Technical difficulties with some of the software in ACS2.0 (believed to be fixed in the recently released ACS2.1).

**Integration, Test, and Support (2920)**

Progress: Carried out the technical activities for the R0 release and regular monthly i



## 2.8 System Engineering and Integration IPT

During the second quarter 2003 the emphasis was on the finalization and approval of the top level documents identified in January 2003 in the Socorro meeting. The documents were presented at the ALMA week in June. The scope of Product Assurance was more precisely defined and the documentation and configuration procedures have been consolidated and simplified. The ALMA product tree was completed in terms of hardware breakdown. System block diagrams have been updated and the error budget allocation progressed but is not finalized.

### Management

A System Engineering Management Plan draft is available and will be submitted for approval third quarter. The level two and three milestones were revised and updated. Weekly progress meetings of the IPT are held and an Action Item list is maintained. Communication with the other IPTs is done by regular working meetings on the North American and European sides and jointly. This quarter, ALMA week was the opportunity for SE&I IPT to meet the different IPTs.

A LO group lead by J. Payne and under the responsibility of SE&I has been created. This LO group is responsible for the LO development across the IPTs. During production the LO responsibility will be handed back to the FE and BE IPTs. Based on the AMAC recommendation the Product Assurance (PA) area was strengthened by nominating a PA manager and the preparation of a PA requirement document. SE involvement into the safety area changed slightly. Now SE is in charge of defining the design safety standards and to perform a system hazard analysis.

### Engineering

#### *System Performance Requirements*

An early draft version of this document made in cooperation with the Science IPT is available. It has been decided that the Science IPT should finalize the document and submit it, as a first step to SE&I IPT.

#### *System Design and Analysis*

The preliminary error budget allocation between the antenna, back-end and front end sub-systems for phase and amplitude stability was prepared. Two ALMA memos 452 and 466 were prepared on that issue. The allocation finalization is regarded as high priority task and needs to be done for the system requirement review beginning of September.

The ALMA system block diagrams were updated and refined; Revision F was released on 2003-Mar-14 and Revision G was released on 2003-May-30. The completeness of the product tree in terms of hardware elements has been checked and was updated accordingly. It was decided to breakdown ALMA hardware including naming and numbering following the Product Tree structure. A new version of the Product Tree has been submitted for approval. A database for ALMA products from which hardware and document breakdown can be derived has been prepared.

### *Interface Control*

Most of the external interface control documents (ICD) were prepared by the IPTs and are now available as draft documents. The ICD status table is continuously updated to reflect the current status. In total 49 external ICDs have been identified. To harmonize the ICD preparation an ICD management plan has been prepared and submitted for approval. Also a new ICD template was prepared.

### Engineering Specifications/Standards and Environment

Following documents have been finalized and submitted for approval:

Electronic Design Specification and Guidelines	ALMA-80.05.00.00-005-A-SPE
EMC Requirements	ALMA-80.05.00.00-005-A-SPE
Power Quality (Compatibility) Specification	ALMA-80.01.00.00-005-B-SPE
Standard for Plugs, Sockets outlets and Couplers	ALMA-80.04.00.00-005-A-STD
ALMA Site Environmental Specifications	ALMA-80.05.02.00-001-A-SPE

### **Product Assurance**

Product Assurance was identified by the AMAC as one topic, where the ALMA project needs to draw higher attention. Consequently the SE & I IPT prepared a Product Assurance requirement document listing all PA requirements for the ALMA project and set-up an ALMA product assurance organization. The document was sent to the management IPT for comments; it will then be circulated for more general comments and then inserted into the approval process. A summary of that document was presented during the ALMA week.

### **Documentation and Configuration Change Control**

The document approval and change request process for project level and IPT level documents has been simplified to avoid all unnecessary or repetitive steps. There will now only be one review and approval path that both the document approval and change request processes will follow. These changes will be implemented upon approval from the CCB and the ALMA Project Director.

To reflect these simplifications, it has been decided to merge the six existing documents on documentation management into two documents. One described the generation of documents

- Documentation Standards and Procedures (standards, identification, numbering...)

And the other the change procedures

- Documentation Control Policies and Procedures (approval, change requests, configuration control...)

The Configuration Control Board (CCB) is now in operation and meets every two weeks. Some documents were approved by the CCB and the document actual approval status is visible on ALMAEDM.

The CCB has appointed Christoph Haupt as CCB secretary for the time being.

Following changes to ALMAEDM and the documentation are planned:

- Creation of a controlled area where project level and IPT level documents are located and maintained by SE.
- All Board level, project level and IPT level document sent to suppliers or sub-contractors need to be signed. A decision for the use of digital signature was made.

## **Integration**

The Integration Plan for the lab system integration of ALMA prototypes hardware and software is in preparation and will be available by the end of the third quarter.

The outline of the Integration Plan of the System in Chile should be available by the end of this year.

The activities of the ALMA Antenna Evaluation Group (AEG) are given elsewhere in this report.

## **Safety**

As mentioned in the previous report, the ALMA Safety Committee, which reports directly to the JAO, will write the ALMA Safety Plan plus safety procedures and policies for construction and interim operations.

SE&I is in charge of the system safety analysis and shall define, together with the different IPTs, the various safety standards to be used.

## **Level 2 Milestones Status for 2003**

<b>MS #</b>	<b>MS Name</b>	<b>Due date</b>	<b>Status</b>
9602	System Requirements Review (SRR) – System Requirements Finalized	2003-09-01	On time
9605	ALMA System Design Review	2003-12-01	On time
9650	Prototype Integration and Verification Plan (Q4 2003 through Q4 2004) approved for Lab and ATF	2003-08-01	On time

## **Critical Areas**

The inventory of requirements documents for the System Requirements Review is nearly complete; there is still uncertainty in the completeness of the list of external ICDs. This will be resolved for the SRR.

The effort in Prototype Integration planning needs to increase to meet the MS# 9650

## ATF Antenna Evaluation Group Quarterly Report: July 2003

### Prototype Antenna Evaluation Planning

#### Staffing

1. A programmer has been assigned by the Computing IPT to the ATF for support of AEG activities. Fritz Stauffer started his duties in this position in May.

#### Communications

*Teleconferences:* The Antenna Evaluation Group (AEG) continues to hold monthly teleconferences. During these teleconferences the detailed planning associated with the evaluation of the VertexRSI and AEC prototype antennas is discussed. The discussions in these teleconferences revolve around:

1. Planning for the installation and use of measurement systems to be used to characterize the prototype antennas.
2. Further definition and planning associated with the major antenna evaluation tasks, which are pointing, surface, radiometric, and monitoring and diagnostics evaluation.
3. Organization of the manpower necessary to execute the major antenna evaluation tasks.
4. Updates to the antenna evaluation task planning resulting from changes in the prototype antenna delivery dates.

With the start of evaluation activities in mid-March came the need for a regular teleconference involving the IPTs responsible for the delivery of instrumentation used in the prototype antenna evaluation process. To meet this need, a weekly teleconference involving the AEG, Computing, Backend, Frontend, Antenna IPTs is held.

*Documentation:* The AEG and AEWG continue to develop the ATF workspace within ALMAEDM as an information storage and distribution system for ATF activities.

*Organization:* The AEG has developed two information systems, available from the ATF web page at <http://atf.nrao.edu> to serve as communication tools for the ATF activities:

1. *ATF Calendars.* Two web-based calendars are used to track daily work schedules at the site and coordinate staffing.
2. *ATF Problem Reports.* Based on the popular "wreq" system used to track computing problems at the NRAO Socorro and Tucson sites, this system allows ATF support staff to track and solve hardware and software problems at this facility.

#### ATF Activities

During this quarter the AEG has begun evaluation of the VertexRSI prototype antenna. Evaluation activities have included:

1. Holographic measurements. This major evaluation task proceeded very smoothly and will be completed somewhat ahead of schedule.
2. Monitoring and diagnostics testing. Measurements using our API 5D laser interferometer, quadrant detector, temperature sensor, accelerometer, and weather monitoring systems have provided some measurements of some of the basic antenna characteristics.
3. Optical pointing measurements. The optical pointing telescope system is nearing completion. Measurements done to date indicate that its performance should meet specification.

### **Current AEG Evaluation Task Timetable**

The current major evaluation task completion schedule is listed below:

VertexRSI Holography	2003-07-03
VertexRSI Optical Pointing	2003-08-25
VertexRSI Radiometric Evaluation	2003-12-26
AEC Holography	2003-11-18
AEC Optical Pointing	2003-12-23
AEC Radiometric Evaluation	2004-02-10

### Problems and Concerns

1. Even though the first major evaluation task on the VertexRSI antenna was completed ahead of schedule, significant hurdles exist on our path to a full evaluation of this antenna. The poor state of the antenna positioning system has become our biggest concern for the evaluation of this antenna. With the assistance of the Computing IPT, we are close to completing an analysis of this problem and hope to work with the contractor on a solution in the coming month.
2. The delays in the delivery of the AEC antenna continue to shift the point at which evaluation of this antenna can be completed further into the future. The AEG has also become concerned about the state of completeness of the AEC antenna system when it is delivered at provisional acceptance. If a lengthy commissioning period is needed to bring the AEC antenna system to the point where the AEG can begin evaluation, further delays in the completion of the evaluation of the AEC antenna will be unavoidable.

## 2.9 Science IPT

During March - June, Science IPT activity concentrated on ALMA calibration, definition of the largest configuration, and operations considerations on the inner array. Revised ICDs (version F) for the inner 172 antenna pads of the ALMA Configuration were approved (see 2.9.2). Work continued on the design of a long baseline part of the plan compatible with this new inner portion, including on-site investigation of pad positions, assessment of excavations at those sites, and recommendations for alternate sites where those excavations uncovered difficult geology for pad positioning. A draft calibration plan for ALMA has emerged.

The Science IPT has started to develop the ALMA "Design Reference Science Plan" (DSRP) which has as the goal to translate the ALMA science case into a more detailed plan of 3 years of observing with the full ALMA array. The DRSP will serve as a quantitative reference for developing the science operations plan, for performing imaging simulations, for software design, and for other applications within the ALMA project. Various Science IPT, ASAC, ESAC, ANASAC and other experts from the community have agreed to contribute to the different scientific sub-themes, and an outline and "observing templates" have been circulated.

The Science IPT arranged the agenda, minutes and telecon for the monthly ASAC telecons and facilitated the ASAC face-to-face meeting in Grenoble April 2-3 to develop its report to the ALMA Board addressing the charges it received. In Europe and North America, the related ESAC and ANASAC groups also hold telecons facilitated by the Science IPT. The Science IPT participated in ALMA Week, the ALMA Computing IPT Review, the AMAC meeting and ALMA Week as well. Joint NA/EU Science IPT staff and Calibration Group telecons were held monthly, and the weekly NA Science IPT telecons were continued.

### ASAC

The Science IPT facilitated the ASAC Telecons held on 5 March 2003, 28 April 2003 and 3 June 2003. It supported the ASAC in the ASAC responses to the Charges posed to it by the ALMA Board, including discussions at the face-to-face meeting 2-3 April in Grenoble, and in the written response presented to the Board at its 26 May 2003 meeting.

### Configuration

The inner configuration for ALMA designed by Conway has gone through a time-consuming comment period and is now approved. The scientific justification was made clearer and the specifications, particularly those relating to antenna closest approach were made more robust. These changes required a small modification in the position of the pads within the central cluster to accommodate the finally agreed upon closest approach distance of 15.15m. Conway also participated in the PDR of the central cluster engineering design held in May. The shadowing and beam performance of the design

incorporating the final design for the altitude of the pads was checked and was found to perform well.

The extended configuration has been the focus for the last quarter. Holdaway designed a configuration to comply with suggestions from the ASAC provided September 2002. During early April, Holdaway and Radford visited Chajnantor to examine and to stake each of the chosen antenna locations. A number of problems were found (for example, one location was difficult to access by road) and Holdaway was able to reoptimize the configuration at the site. Coordinates were supplied to the Site IPT, which reported back soil studies at each of the flagged locations. Holdaway has proposed new sites on the basis of this feedback, and has submitted an iterated plan by the 30 June 2003 date for the milestone.

Conway has examined the sequence of moves needed to move the array from its innermost configuration to its outermost configuration and back again. In particular, a detailed reconfiguration scheme optimised for North-South reconfiguration, which minimizes shadowing and maximizes sensitivity has been made. A draft document describing these moves has been produced, an important input to the Operations Group planning tasks on the site. Finally in collaboration with geophysicists, investigations were made into the effect of Moon and solar tides on pad positions and the effect on baseline calibration.

## **Calibration**

A draft calibration strategy was produced by Butler for limited circulation and comments, as a basis for the calibration session at ALMA Week 2003 involving many Science IPT members. That session was very productive, giving a snapshot of our current thinking on the major items of the calibration plan and some discussion on still unresolved issues. The following calibration requirements were derived for the main calibration components of ALMA:

- Amplitude calibration to 1% at  $f < 300$  GHz; 3% at  $f > 300$  GHz has been specified, which implies (i) A calibration system in front of the receivers to track fluctuations in system temperature. This system must allow the receivers to be coupled with the following input signals:
  - o "hot" load
  - o "ambient" load
  - o sky
  - o combination of 50 % "hot" and 50 % sky
  - o combination of 50 % "ambient" and 50 % sky.
 The temperatures of the loads remain to be specified in detail, but that of the "hot" load should be 370 K or above, and that of the "ambient" load should be 283 K or lower. This calibration system must apply to all receiver bands except band 1. Different technical solutions exist for the combinations of loads (semi-transparent vane; wire grid; dielectric beamsplitter), but more testing is needed to choose between them. The dual-load in the subreflector has been abandoned. (ii) A system of measuring calibrator flux densities in an absolute sense. The details of such a system are TBD, but one such system involves the use of standard horns which have absolutely calculated or measured gain, used interferometrically with the ALMA (or ACA) antennas.

- Phase calibration of the fluctuating atmospheric component of delay to  $10 \cdot (1.1 + \text{PWV})$  microns of path length, where PWV is the precipitable water vapor in mm, which

implies: (i) Ability to use the fast switching by itself to reach this requirement when atmospheric conditions and observing frequency permit; (ii) Ability to track the atmospheric fluctuations with a WVR system; (iii) Ability to calibrate that WVR system using a combination of internal loads (for calibrating the temperature scale of the radiometers) and observations of astronomical sources to calibrate the conversion from WVR observable to interferometric phase. Here the fast switching capability of the antennas can be used, where the switching timescale is of order 10's of seconds to minutes. Richer, Hills and the water vapour radiometer team made a detailed presentation on the WVRs at ALMA week to the JAO and IPT leads: this was focused on the specification of the instruments, the proposed atmospheric modelling work required, and the agreed instrumental testing programme. In Cambridge, funding is now in place for a new Science IPT member to work primarily on radiometric phase correction, and recruitment for this 2-year post has begun; the hope is to have the new person in post by October 2003.

- Bandpass calibration to 1 part in 1000 for all cases, 1 part in 10000 in select situations, which implies: (i) The subreflector must be equipped with a scattering (or "tangent") cone, tangent to the hyperboloid at a radius TBD (1.2 to 1.5 times the radius of the blockage zone) from the apex; (ii) This scattering cone must be removable; (iii) The possibility for a broad-band, coherent emitter (some type of photonic, likely) to be installed in the subreflector must be retained - implying also fiber optic cabling to the subreflector; (iv) The total mass for either the scattering cone or photonic emitter must not exceed 5 kg. Bacmann and Guilloteau have finished the memo on standing waves which is now circulating for comments. They are still working on the bandpass calibration memo, which will be submitted soon.

- Polarization calibration to 0.1% in amplitude, 6 deg in polarization angle. In addition: (i) A quarter wave plate should be available for Band 7; (ii) The calibration load system should be useable in combination with the quarter wave plate; (iii) Software support for polarization calibration is urgently needed.

A number of other requirements have been developed or adopted for other calibration components of ALMA (pointing, antenna location, etc...), and will be elaborated in a forthcoming document describing in much more detail all aspects of calibration of ALMA. Richer and Hills completed the paper detailing the ancillary calibration devices needed by ALMA.

Work on the ALMA-ATM library continued in by Pardo, Viallefond and collaborators. A first release for linux platforms was produced by the end of May and is accessible to the ALMA project (password protected) at:

<http://www.aoc.nrao.edu/~bbutler/work/alma/calibration/>.

The release consists of a library containing all the objects corresponding to the "primary" routines of the code plus 4 routines to link with the outside world. Full documentation of the MAIN program, examples, and 'link' routines are also provided. In collaboration with IRAM, the first implementation of the ALMA-ATM library in GILDAS has been made. Extension to other platforms is planned for later this year.



## Site Characterization

Instrumentation on site continues to produce data for characterization. There is a problem with one of the solar power units, which needs to be solved by an electrician. Discussions were held with Canadian interests on the possible deployment of IRMA, an infrared device very sensitive to water vapor content of the atmosphere, to Chajnantor.

Nyman and co-workers published ALMA memo 451 on "Some error sources for the PWV and path delay estimated from 183 GHz radiometric measurements at Chajnantor". The radiometers have now been set up to take data for the determination of the height of the turbulent layer. A new workstation was purchased to reduce the data and all the historical radiometer data for determination of PWV will be rereduced with improved software. The analysis of the data to determine the wind power spectrum has started. This will take longer than expected because there are gaps in the data at irregular time intervals, which need to be removed from the data sets.

Holdaway massaged the collection of site testing data into homogeneous form, using aips++. This allowed the construction of a stringency tool within aips++, which will allow its use within more complex scripts during the Design Reference Science Plan assessment. The tool will be expanded to allow modeling of WVR residual phase errors, fast switching phase errors, and the detailed calculation of stringency on short time periods.

## Imaging

The role of the ACA remains under investigation, with most of the effort being undertaken in Japan. The Science IPT tracks and provides advice on these activities. Holdaway worked on a memo on ACA phase stability which will be produced when completion of the configuration work allows it to be completed.

Gueth and Pety set up an interferometric OTF experiment at the Plateau de Bure Interferometer in order to gain experience on data reduction of this important observing mode for ALMA. This experiment will take place next summer and winter.

## Organization, interaction with other IPTs

A monthly telecon continues for the whole Science IPT, and there is a weekly telecon of the NA Science Team. Topics under intense discussion continue to center on the calibration plan. In addition, several discussions on Operations were held. In NA, Wootten made a presentation during one of the weekly science meetings to attendees from NRAO and HIA on the operations phase of ALMA, to broaden and enlighten the discussions occurring in various more focused groups.

During May-June, the Science IPT supported the LO Group in tests of the prototype ALMA 'conventional LO' in Green Bank, West Virginia. A preprototype ALMA 3mm receiver was used, providing a full 4-12 GHz IF at stunning performance (17 K DSB). The Green Bank Telescope Spectrometer provided the back end. In addition to the ALMA LO, a standard Gunn LO was also used for comparison. The system worked very

well and it was demonstrated that the tunerless ALMA LO design performed very similarly to the more highly tuned Gunn design employed in observatories for many years.

Richer is finalising the Science IPT paper on data rates, which will be submitted in early July to the SSR group and Computing IPT.

### **Meetings, Outreach and Public Education**

Wootten made ALMA presentations at the Herzberg Institute of Astrophysics and at the 2003 IEEE AP-S International Symposium and USNC/CNC/URSI National Radio Science Meeting on ALMA. He also made a video presentation on the operations phase of ALMA to sites across North America and proposed a 'Town Meeting' session at the next meeting of the American Astronomical Society, to be held in Atlanta. The AAS Council recommended that such a session be held, and scheduled it for lunchtime on 8 January 2004.

Testi co-organized a meeting on submillimeter science and the promise of ALMA in May in Italy, attended by ~60 scientists. Richer communicated the status of ALMA to the UK community at its annual Royal Astronomical Society meeting in April. Van Dishoeck presented a lecture on ALMA science drivers and operations in June at an ALMA meeting in Porto for Portuguese astronomers. She also presented various outreach talks involving ALMA to Belgian and Dutch communities. Shaver interacted strongly with the ESO public relations department to develop new ALMA display material for the IAU General Assembly in Sydney in July.

### **Concerns**

As elucidated in the Front End IPT's session at ALMA Week, the Science IPT remains concerned that calibration with ALMA prototype receivers will not occur until early 2006 in Chile, uncomfortably close to the 'First Science' milestone. The WVR system provides a critical part of the phase correction system needed for ALMA to work at high frequencies and on long baselines. If the ATF is dismantled in late 2004 it will not be possible to test this system until early 2006 on Chajnantor.

Since the Science IPT interacts with many other IPTs, a critical look at whether its milestones are compatible with those of different IPTs is needed. The Science IPT also urges the project to publish and disseminate minutes and action lists for the JAO/IPT and other meetings.

## Acronym Definitions

ABM	ALMA Bus Master
ACA	Atacama Compact Array
ACE	Alcatel/Costamasnaga/EIE
ACS	ALMA Common Software
ACU	Antenna Control Unit
AEG	Antenna Evaluation Group
AEWG	Antenna Evaluation Working Group
AIPS++	Astronomical Information Processing System
ALMAEDM	ALMA Electronic Document Manager
AOS	Array Operations Site
ASAC	ALMA Science Advisory Committee
ATF	Antenna Test Facility
BIMA	Berkeley Illinois Maryland Association
BUS	Back Up Structure
CDR	Critical Design Review
CFRP	Carbon Fiber Reinforced Plastic
CSIC	Consejo Superior de Investigacion Cientificas
CVS	Concurrent Version System
DC	Direct Current
DSB	Double Side Band
DTS	Data Transmission System
EAB	European ALMA Board
ESAC	European Scientific Advisory Committee
ESO	European Southern Observatory
FE	Front End
FEIC	Front End Integration Center
FIR	Finite Impulse Response
FPGA	Field Programmable Gate Array
FO	Fiber Optics
FTE	Full Time Equivalent
FTS	Fourier Transform Spectrometer
HIA	Herzberg Insitute of Astrophysics
ICD	Interface Control Document
IF	Intermediate Frequency
IPT	Integrated Product Team
IRAM	Institut Radio Astronomie Millimetrique
JAO	Joint ALMA Office
JBO	Jodrell Bank Observatory
LO	Local Oscillator
LORR	Local Oscillator Reference Receiver
LTA	Long Term Accumulator
LVDS	Low Voltage Digital Signal
MMIC	Millimeter Integrated Circuit
MRAO	Mullard Radio Astronomy Observatory
NAOJ	National Astronomical Observatory of Japan

NOVA	Netherlands Research School for Astronomy
NRAO	National Radio Astronomy Observatory
OAN	Observatorio Astronomico Nacional
OSF	Operations Support Facility
OVRO	Owens Valley Radio Observatory
PCB	Printed Circuit Board
PDR	Preliminary Design Review
PTC	PoinTing Computer
RAL	Rutherford Appleton Laboratory
RF	Radio Frequency
SE&I	System Engineering and Integration
SIS	Superconducting Insulator Superconducting
SRON	Space Research Organization Netherlands
SSR	Scientific Software Requirements
XML	Extended Markup Language
YO	Yebes Observatory
2GC	2nd Generation Correlator