

## 0.5dB LSB GaAs MMIC 6-BIT DIGITAL ATTENUATOR, DC - 13 GHz

### Typical Applications

The HMC424LP3 is ideal for:

- Basestation Infrastructure
- Fiber Optics & Broadband Telecom
- Microwave & VSAT Radios
- Military & Space
- Test Instrumentation

### Features

- 0.5 dB LSB Steps to 31.5 dB
- Single Control Line Per Bit
- +/- 0.5 dB Typical Bit Error
- 9mm<sup>2</sup> Leadless SMT Plastic Package

### Functional Diagram

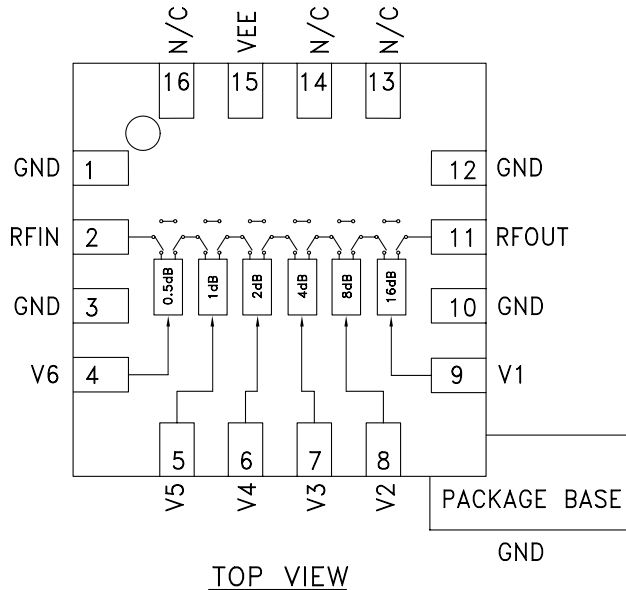

### General Description

The HMC424LP3 is a broadband 6-bit GaAs IC digital attenuator in a low cost leadless surface mount package. Covering DC to 13 GHz, the insertion loss is less than 4 dB typical. The attenuator bit values are 0.5 (LSB), 1, 2, 4, 8, and 16 dB for a total attenuation of 31.5 dB. Attenuation accuracy is excellent at ± 0.5 dB typical step error with an IIP3 of +32 dBm. Six control voltage inputs, toggled between 0 and -5V, are used to select each attenuation state. A single Vee bias of -5V allows operation at frequencies down to DC.

### Electrical Specifications, $T_A = +25^\circ C$ , With Vee = -5V & VCTL= 0/-5V

Parameter	Frequency (GHz)	Min.	Typ.	Max.	Units
Insertion Loss	DC - 4.0 GHz		3.1	3.8	dB
	4.0 - 8.0 GHz		3.5	4.0	dB
	8.0 - 13.0 GHz		4.0	4.6	dB
Attenuation Range	DC - 13.0 GHz		31.5		dB
Return Loss (RF1 & RF2, All Atten. States)	DC - 13.0 GHz	9	12		dB
Attenuation Accuracy: (Referenced to Insertion Loss)	DC - 13.0 GHz	0.5 - 15.5 dB States		± 0.3 + 3% of Atten. Setting Max	dB
		16 - 31.5 dB States			± 0.3 + 5% of Atten. Setting Max
Input Power for 0.1 dB Compression	1.0 - 13.0 GHz		22		dBm
Input Third Order Intercept Point (Two-Tone Input Power= 0 dBm Each Tone)	1.0 - 13.0 GHz	REF State		46	dBm
		All Other States		32	dBm
Switching Characteristics	DC - 13.0 GHz				
tRISE, tFALL (10/90% RF)			30		ns
tON/tOFF (50% CTL to 10/90% RF)			50		ns

## 0.5dB LSB GaAs MMIC 6-BIT DIGITAL ATTENUATOR, DC - 13 GHz

### Insertion Loss

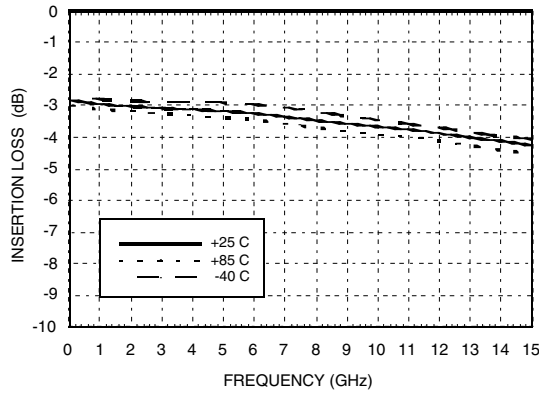

### Return Loss RF1, RF2 (Only Major States are Shown)

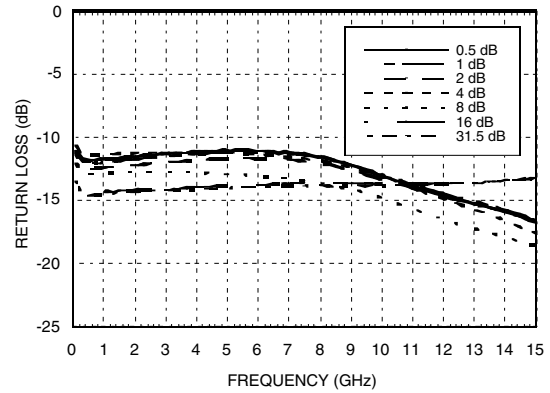

### Normalized Attenuation (Only Major States are Shown)

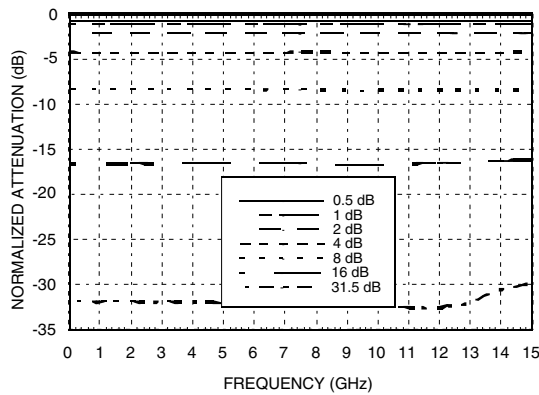

### Bit Error vs. Attenuation State

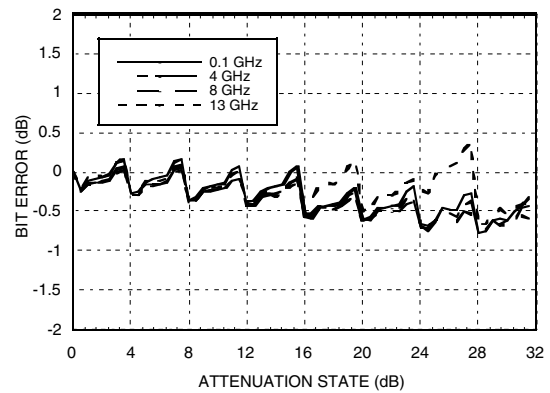

### Bit Error vs. Frequency (Only Major States are Shown)

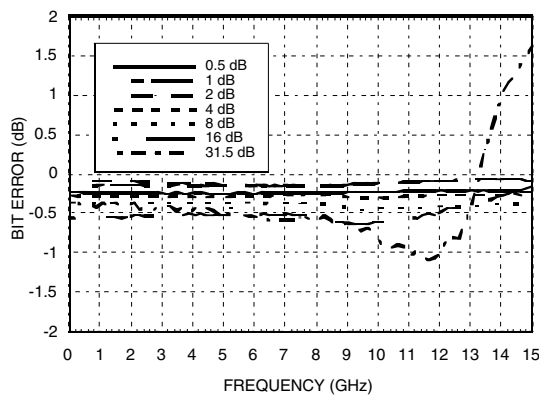

### Relative Phase vs. Frequency (Only Major States are Shown)

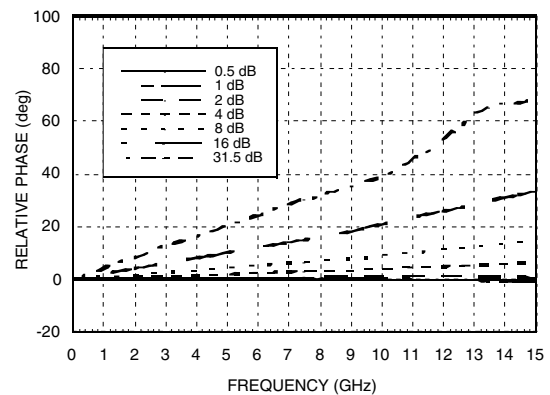

## 0.5dB LSB GaAs MMIC 6-BIT DIGITAL ATTENUATOR, DC - 13 GHz

### Worst Case Step Error Between Successive Attenuation States

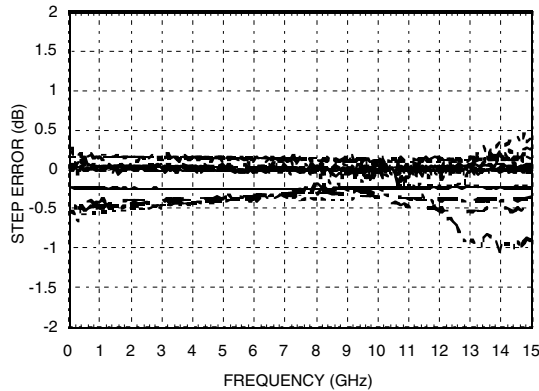

### Bias Voltage & Current

Vee Range= -5.0 Vdc ± 10%		
Vee (VDC)	Iee (Typ.) (mA)	Iee (Max.) (mA)
-5.0	2	4

### Control Voltage

State	Bias Condition
Low	0 to -3V @ 70 µA Typ.
High	-5 to -4.2V @ 5 µA Typ.

### Truth Table

Control Voltage Input						Attenuation State RF1 - RF2
V1 16 dB	V2 8 dB	V3 4 dB	V4 2 dB	V5 1 dB	V6 0.5 dB	
Low	Low	Low	Low	Low	Low	Reference I.L.
Low	Low	Low	Low	Low	High	0.5 dB
Low	Low	Low	Low	High	Low	1 dB
Low	Low	Low	High	Low	Low	2 dB
Low	Low	High	Low	Low	Low	4 dB
Low	High	Low	Low	Low	Low	8 dB
High	Low	Low	Low	Low	Low	16 dB
High	High	High	High	High	High	31.5 dB

Any Combination of the above states will provide an attenuation approximately equal to the sum of the bits selected.

## 0.5dB LSB GaAs MMIC 6-BIT DIGITAL ATTENUATOR, DC - 13 GHz

### Absolute Maximum Ratings

Control Voltage (V1 to V6)	Vee - 0.5 Vdc
Bias Voltage (Vee)	-7.0 Vdc
Channel Temperature	150 °C
Thermal Resistance	140 °C/W
Storage Temperature	-65 to + 150 °C
Operating Temperature	-55 to +85 °C
RF Input Power (0.5 - 13.0 GHz)	+25 dBm

### Outline Drawing

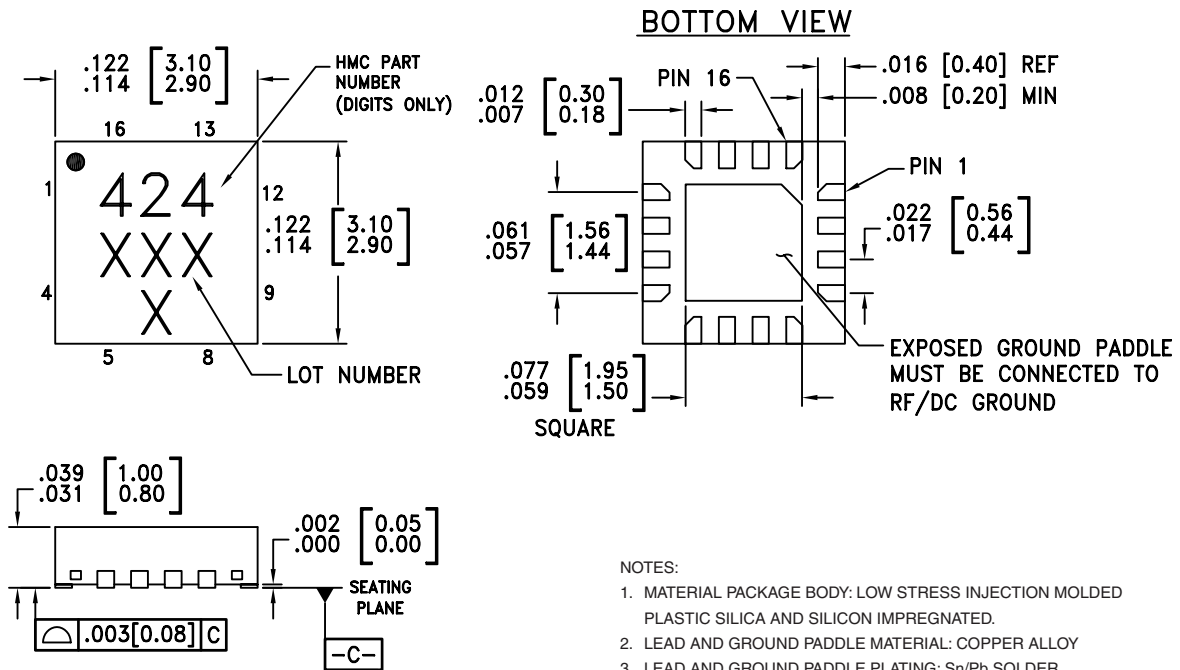



NOTES:

1. MATERIAL PACKAGE BODY: LOW STRESS INJECTION MOLDED PLASTIC SILICA AND SILICON IMPREGNATED.
2. LEAD AND GROUND PADDLE MATERIAL: COPPER ALLOY
3. LEAD AND GROUND PADDLE PLATING: Sn/Pb SOLDER
4. DIMENSIONS ARE IN INCHES [MILLIMETERS].
5. LEAD SPACING TOLERANCE IS NON-CUMULATIVE
6. PAD BURR LENGTH SHALL BE 0.15mm MAXIMUM. PAD BURR HEIGHT SHALL BE 0.05mm MAXIMUM.
7. PACKAGE WARP SHALL NOT EXCEED 0.05mm.
8. ALL GROUND LEADS AND GROUND PADDLE MUST BE SOLDERED TO PCB RF GROUND.
9. REFER TO HITTITE APPLICATION NOTE SUGGESTED PCB LAND PATTERN.

## 0.5dB LSB GaAs MMIC 6-BIT DIGITAL ATTENUATOR, DC - 13 GHz

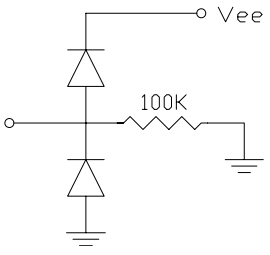
### Pin Description

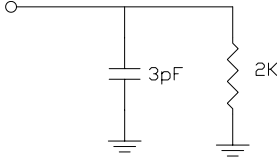
Pad Number	Function	Description	Interface Schematic
1, 3, 10, 12	GND	Package bottom has an exposed metal paddle that must also be connected to RF ground	
2, 11	RFIN, RFOUT	This pin is DC coupled and matched to 50 Ohm. Blocking capacitors are required if RF line potential is not equal to 0V.	
4, 5, 6, 7, 8, 9	V6 - V1	See truth table and control voltage table.	
13, 14, 16	N/C	This pin should be connected to PCB RF ground to maximize performance	
15	VEE	Supply Voltage -5V ± 10%	

### Suggested Driver Circuit (One Circuit Required Per Bit Control Input)

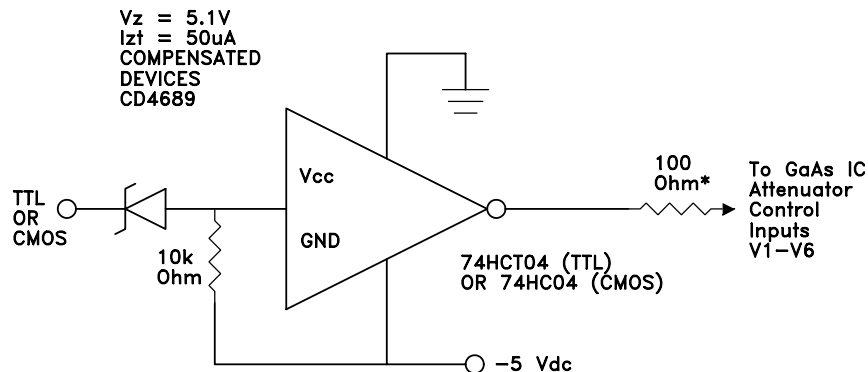

Simple driver using inexpensive standard logic ICs provides fast switching using minimum DC current.

\* Recommended value to suppress unwanted RF signals at V1 - V6 control lines.

## 0.5dB LSB GaAs MMIC 6-BIT DIGITAL ATTENUATOR, DC - 13 GHz

### Evaluation PCB

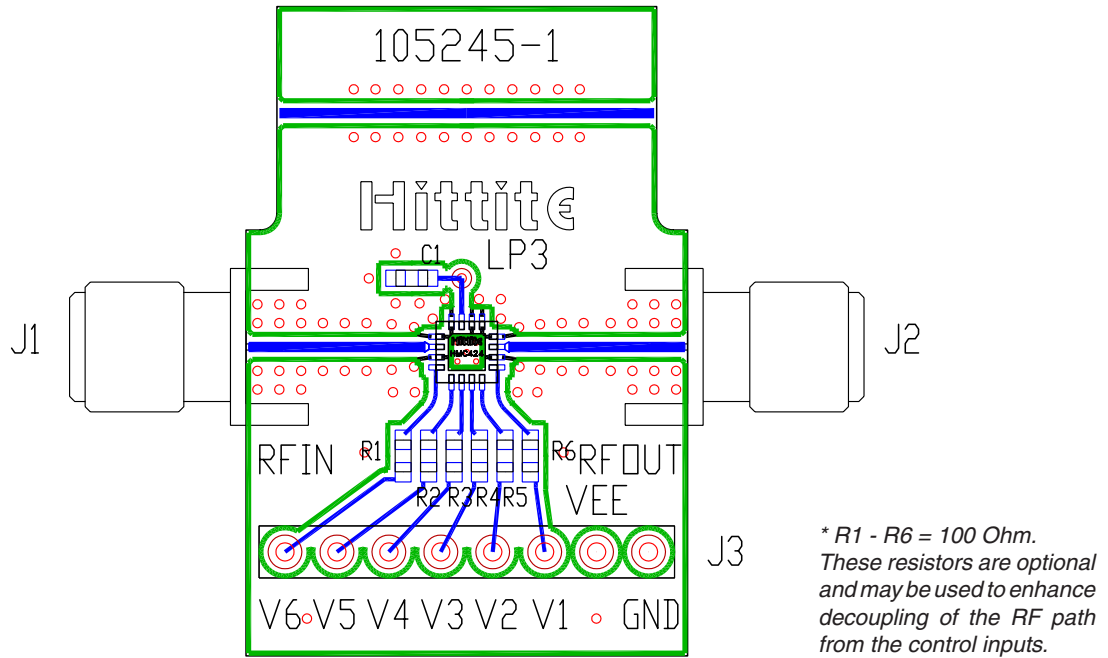

The circuit board used in the final application should use RF circuit design techniques. Signal lines should have 50 ohm impedance while the package ground leads and exposed paddle should be connected directly to the ground plane similar to that shown. A sufficient number of via holes should be used to connect the top and bottom ground planes. The evaluation circuit board shown is available from Hittite upon request.

### List of Material

Item	Description
J1 - J2	PC Mount SMA Connector
J3	8 Pin DC Connector
C1	0.01 $\mu$ F Capacitor, 0603 Pkg.
R1 - R6	100 Ohm Resistor, 0603 Pkg.
U1	HMC424LP3 Digital Attenuator
PCB*	105245 Evaluation PCB
* Circuit Board Material: Rogers 4350	

This datasheet has been download from:

[www.datasheetcatalog.com](http://www.datasheetcatalog.com)

Datasheets for electronics components.